

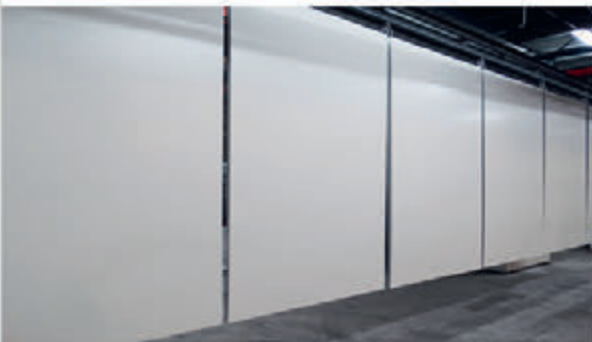

COLECCIÓN 2019

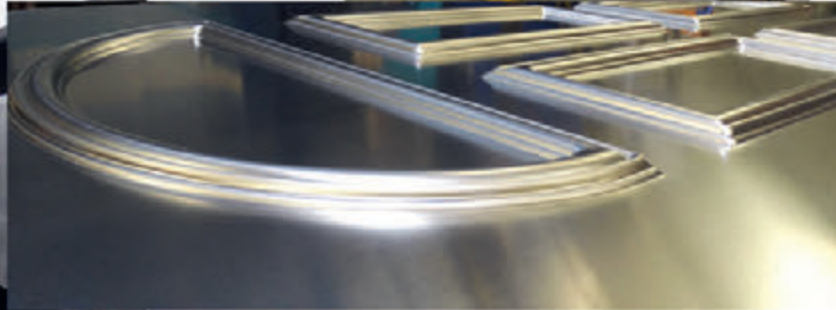
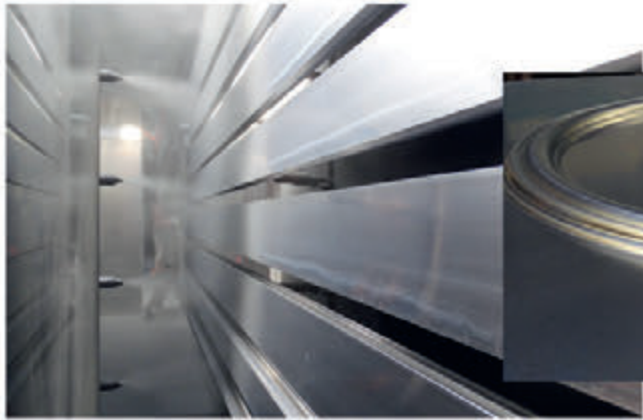
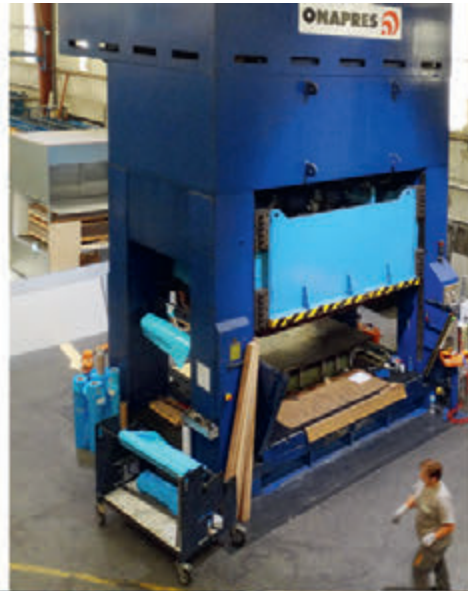
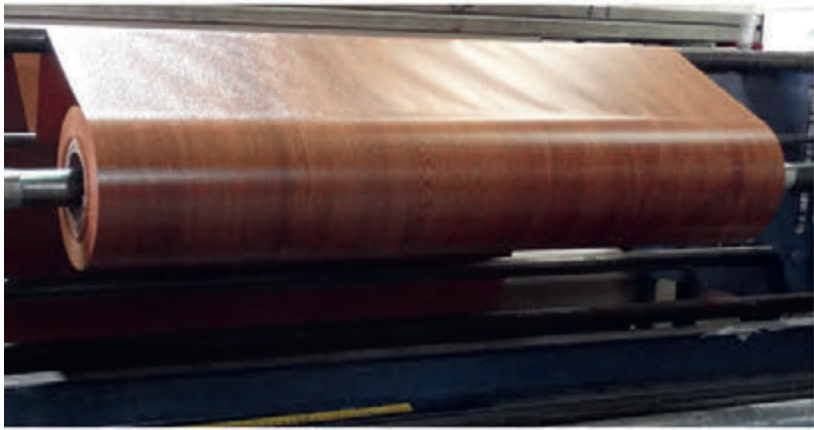

Nuestra empresa Estampaciones Técnicas de Galicia, S.I. (**ESTEGA, S.L.**) fue constituida en el año 2001, iniciando su actividad en marzo del 2002. En un primer paso, iniciamos nuestra actividad industrial en el sector de la transformación de chapa de aluminio para puertas de entrada con la adquisición de una prensa hidráulica de 1.600 T.M. en la mesa principal y 800 T.M. de cojín, con unas dimensiones máximas de 3.200 x 2.400mm. útiles de mesa. Este hito supuso desde un primer momento un elemento diferenciador, ya que nos convirtió en la empresa a nivel europeo con la mayor prensa para la embutición de chapa del sector, tanto por capacidad de producción, como calidad y dimensiones. Gracias a nuestra prensa se nos han abierto las puertas a la exportación, suponiendo hoy en día este mercado más de un 50% de nuestra cifra de negocio.

A lo largo de los años, y manteniendo la filosofía inicial, nos hemos basado no sólo en parámetros de capacidad de producción, sino también hemos tenido muy en cuenta los valores de calidad y diferenciación con el resto de competidores tanto nacionales como internacionales a la hora de ir afrontando las nuevas adquisiciones de equipamientos productivos.

Año tras año, **ESTEGA**, ha ido incorporando a su ajuar industrial nuevos y modernos medios y líneas de fabricación, en la búsqueda de una mejora continua y poder de este modo atender los mercados cada vez más exigentes a los que día a día llegamos.

Hoy, además de la prensa de estampación, que es y será nuestro buque insignia, disponemos de línea de corte para poliestireno XPS, 2 centros de mecanizado C.N.C , una línea robotizada de encolado HOT-MELT para foliado de chapas y pegado de panel sándwich , línea de sublimado efecto madera 3D para chapas y perfiles, línea de lacado horizontal de gran capacidad, termoconformadora de PVC y una estación robotizada de corte, punzonado , plegado de chapa para la fabricación de nuestra puerta AVANZA y el panelado de puertas de los principales actores del PVC a nivel europeo.

Pero no podemos dejar de mencionar el equipo humano que conforma **ESTEGA**, trabajadores con una amplia experiencia en el sector, y en su mayoría, en la propia empresa. Personal que se vuelca diariamente en atender las necesidades de cada cliente, buscando soluciones particulares para cada caso, dando apoyo técnico y resolutivo para cualquier consulta que llegue desde el cliente o departamento comercial.

ESTAMPACIÓN



ARACO Pag. 6 BAKRA Pag. 8 BLONDY Pag. 9 CELTA Pag. 10 DRAGO Pag. 11 ELVAR Pag. 12

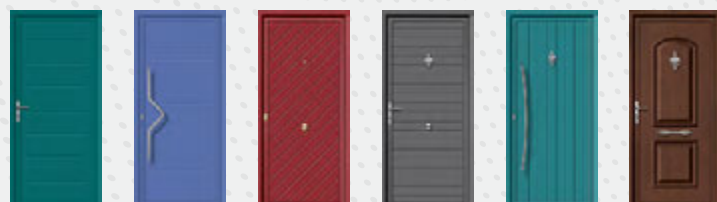

FALCA Pag. 14 FOQUE Pag. 15 GAZMI Pag. 16 HALGA Pag. 17 ISOCA Pag. 25 JEREZ Pag. 30



KORSÁ Pag. 32 LEYNE Pag. 34 MALMO Pag. 35 NOLSO Pag. 36 OLVIA Pag. 37 PERLA Pag. 38



SAGRA Pag. 39 TRIMO Pag. 40 URBAN Pag. 41 VESTA Pag. 42 TERCIOS Pag. 43 CASTELLANO Pag. 48

SEDUCCIÓN

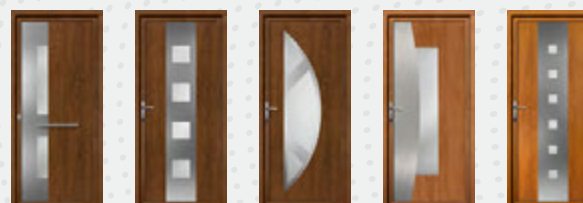

AIDA Pag. 52 ALBA Pag. 53 CARLA Pag. 54 CELIA Pag. 55 CLARA Pag. 56

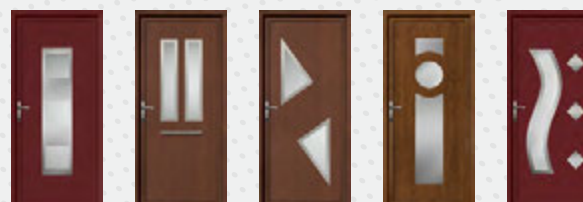

CLAUDIA Pag. 57 ELENA Pag. 58 GEMMA Pag. 59 JULIA Pag. 60 LAURA Pag. 61



MARÍA Pag. 62 MARTA Pag. 63 NINA Pag. 64 OLGA Pag. 65 ROCÍO Pag. 66

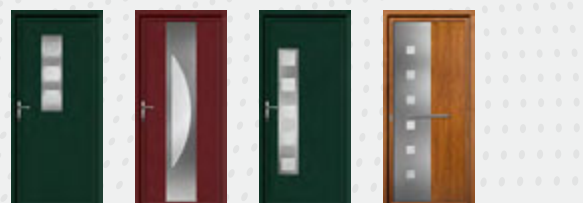

ROSA Pag. 67 SARA Pag. 68 SOFÍA Pag. 69 TANIA Pag. 70

FANTASÍA



ARGEL Pag. 72 BERLÍN Pag. 72 CAIRO Pag. 73 DAKAR Pag. 74



HELSINKI Pag. 78 KAMPALA Pag. 79 KIEV Pag. 80 LIMA Pag. 81



OSLO Pag. 85 PARÍS Pag. 86 PEKÍN Pag. 87 PRAGA Pag. 88



TAURO Pag. 92 TOKIO Pag. 93 TÚNEZ Pag. 94 VIENA Pag. 95

FUTURA



DUBLÍN
Pag. 75



ESTOCOLMO
Pag. 76



GUATEMALA
Pag. 77



ALTAR
Pag. 99



AUSTRAL
Pag. 100

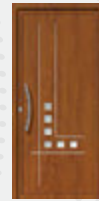

BOREAL
Pag. 101



BURIL
Pag. 102

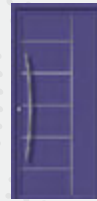

CAPRICORNIO
Pag. 103



CASIOPEA
Pag. 104



CEFEO
Pag. 105

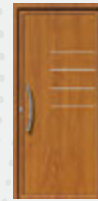

CENIT
Pag. 106

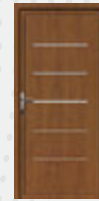

CENTAURO
Pag. 107



LISBOA
Pag. 82



MADRID
Pag. 83



MOSCÚ
Pag. 84



CINCEL
Pag. 108



DELFIN
Pag. 109



ERIDANO
Pag. 110



ESCORPIO
Pag. 111



FÉNIX
Pag. 112



GAMMA
Pag. 113



GRULLA
Pag. 114



HADAR
Pag. 115



HÉRCULES
Pag. 116



QUILLA
Pag. 89

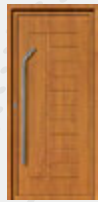

QUITO
Pag. 90



ROMA
Pag. 91



HIDRA
Pag. 117



INCA
Pag. 118



KIMA
Pag. 119

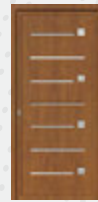

LIBRA
Pag. 120



OCTANTE
Pag. 121



OLIMPO
Pag. 122



PEGASO
Pag. 123



PERSEO
Pag. 124



REGULO
Pag. 125



YAKARTA
Pag. 96



SAGITARIO
Pag. 126



SERPEN
Pag. 130



SIGMA
Pag. 131



TAU
Pag. 132



TAURO II
Pag. 133



VELA
Pag. 134



VIRGO
Pag. 135

PVC CONFORMADO



DIANA
Pag. 138

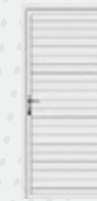

HADES
Pag. 139



IRIS
Pag. 144



JÚPITER
Pag. 147



MARTE
Pag. 148



ORIÓN
Pag. 149



POSEIDÓN
Pag. 150



SEXTANTE
Pag. 151

ACCESORIOS



ALUMINIO
Pag. 154



INOX
Pag. 156



REJAS
Pag. 157



VIDRIOS
Pag. 162

ACABADOS



Pag. 4

ACABADOS



ANODIZADO



FOLIADO



LACADO MADERA



LACADO RAL



ESTAMPACIÓN

NÚCLEOS

XPS: $U = 1,57 \text{ W/m}^2 \text{ }^\circ\text{K}$

ALMA MIXTA: $U = 2,03 \text{ W/m}^2 \text{ }^\circ\text{K}$

TABLERO MARINO: $U = 2,77 \text{ W/m}^2 \text{ }^\circ\text{K}$

OPCIONES

Refuerzo Chapa Aluminio

Blindaje Chapa Acero

MEDIDAS FABRICACIÓN

2000 x 800

2100 x 900

2200 x 1000

2300 x 1250

ACABADOS

LACADOS RAL

ANODIZADO

LACADO MADERA

FOLIADO

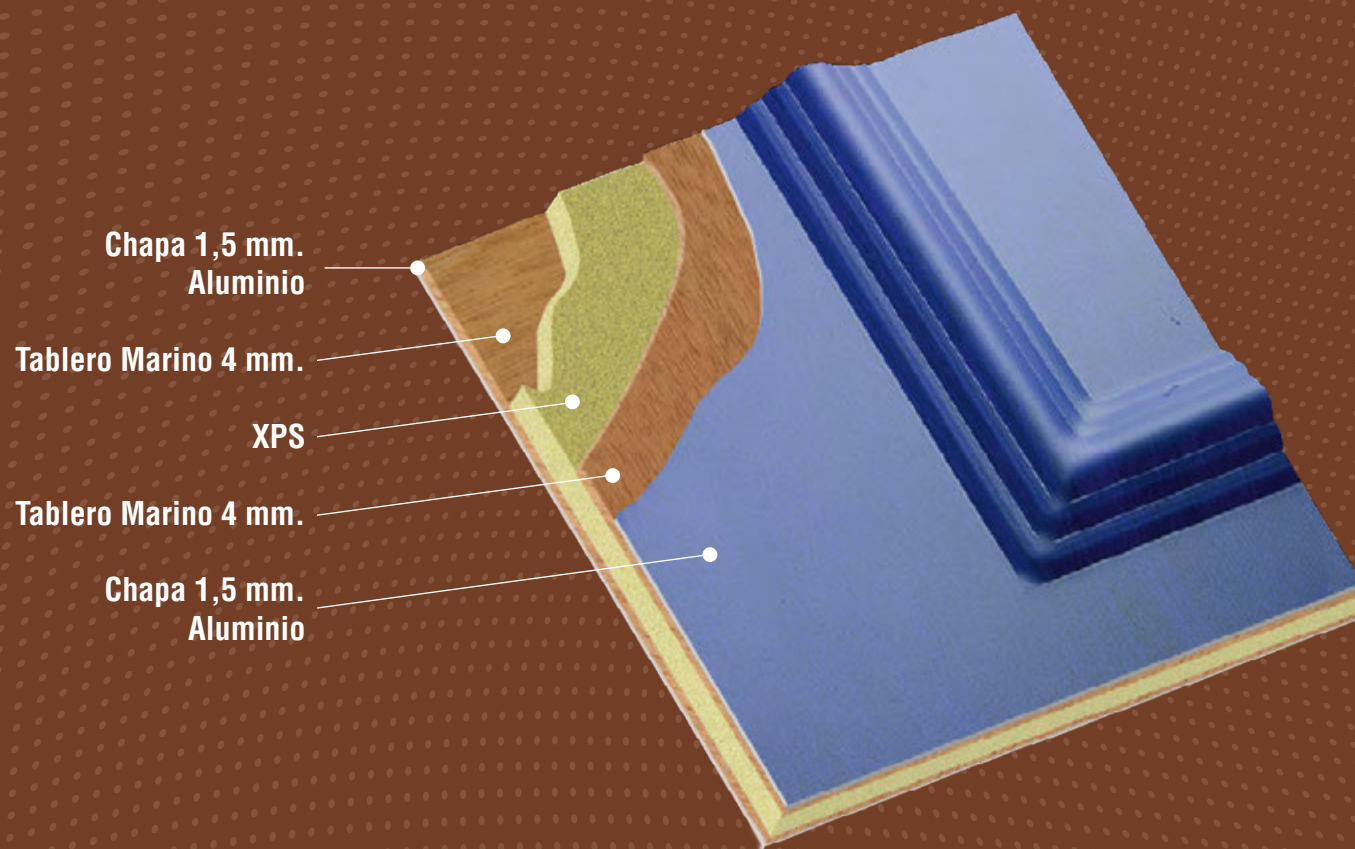

Vista de todos los modelos: Exterior.

ARACO



ARACO



ARACO
1 vidrio sin barrotillo



ARACO
3 vidrios barrotillo oro



ARACO
5 vidrios barrotillo blanco



ARACO
7 vidrios barrotillo oro

- Aluminio
- Pvc
- Lacado Ral
- Anodizado
- Lacado Madera
- Foliado

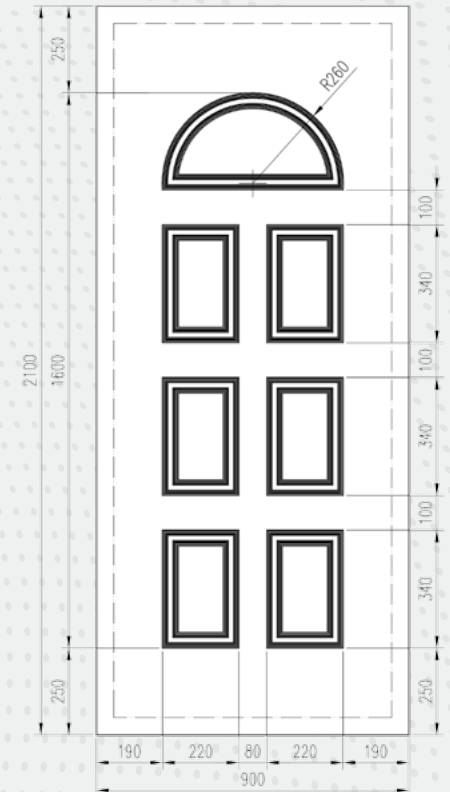

ARACO



ARACO
con tercio

- Aluminio
- Pvc
- Lacado Ral
- Anodizado
- Lacado Madera
- Foliado

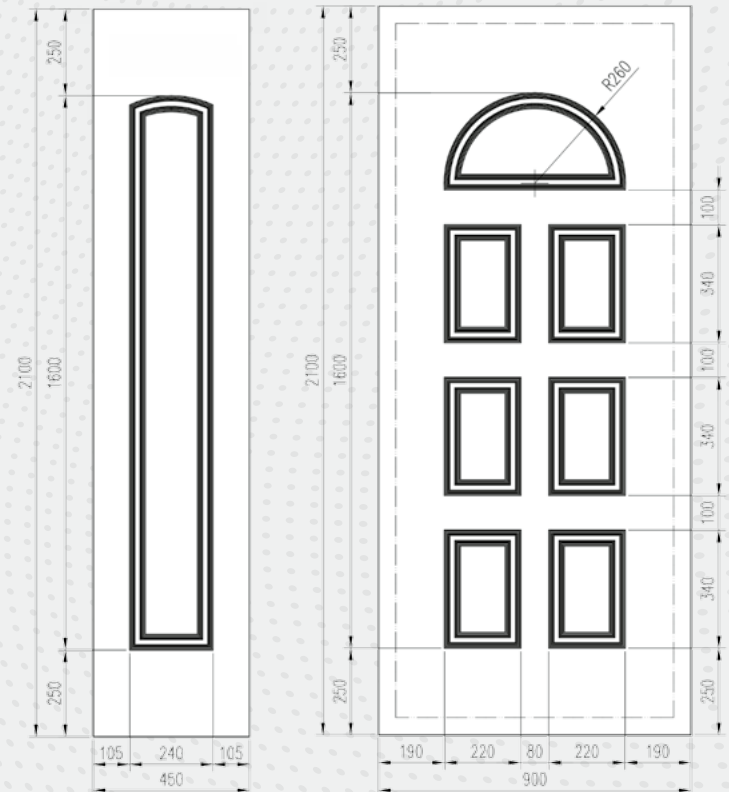

BAKRA



BAKRA



BAKRA
1 vidrio barrotillo blanco



BAKRA
1 vidrio barrotillo oro



BAKRA
1 vidrio sin barrotillo



BAKRA
1 vidrio emplomado

- Aluminio
- Pvc
- Lacado Ral
- Anodizado
- Lacado Madera
- Foliado

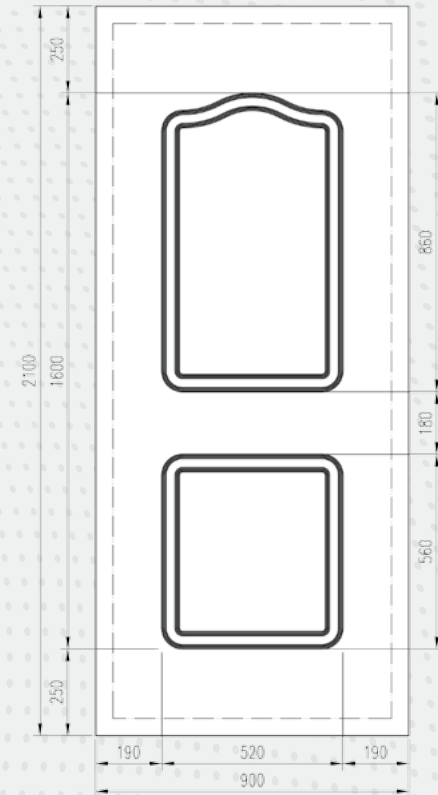

BLONDY



BLONDY

- Aluminio
- Pvc
- Lacado Ral
- Anodizado
- Lacado Madera
- Foliado

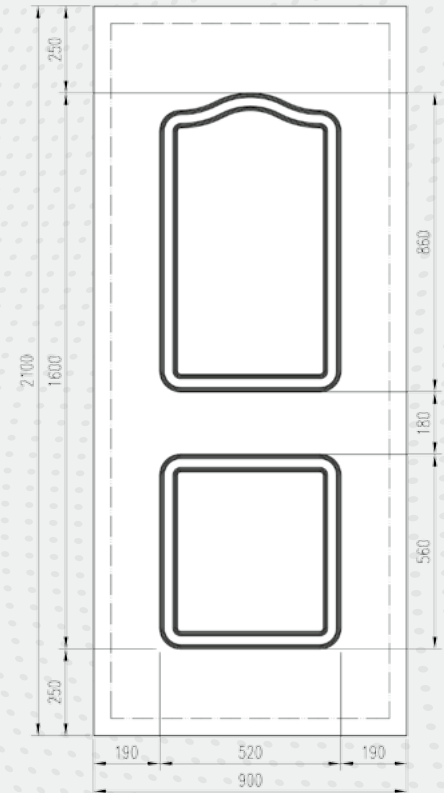

CELTA



CELTA



CELTA
vidrio mate



CELTA
vidrio fussing 1



CELTA
vidrio fussing 2



CELTA
vidrio fussing 3



CELTA
vidrio fussing 4

- Aluminio
- Pvc
- Lacado Ral
- Anodizado
- Lacado Madera
- Foliado

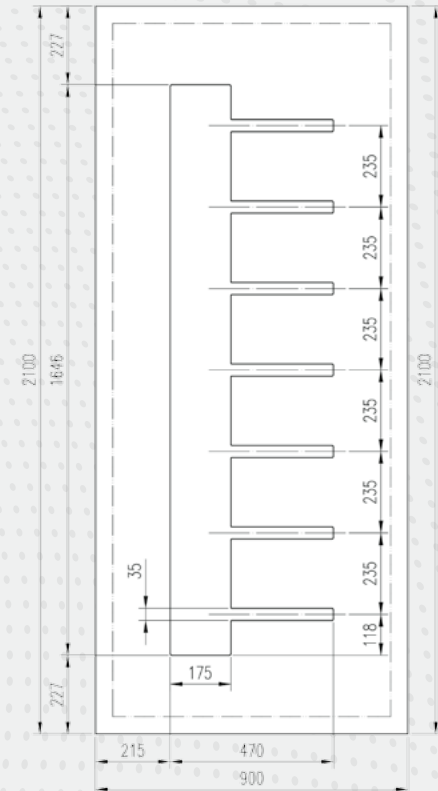

DRAGO



DRAGO



DRAGO
2 vidrios barrotillo blanco



DRAGO
2 vidrios barrotillo oro



DRAGO
2 vidrios sin barrotillo



DRAGO
2 vidrios emplomados



DRAGO
2 vidrios barrotillo oro con tercio

- Aluminio
- Pvc
- Lacado Ral
- Anodizado
- Lacado Madera
- Foliado

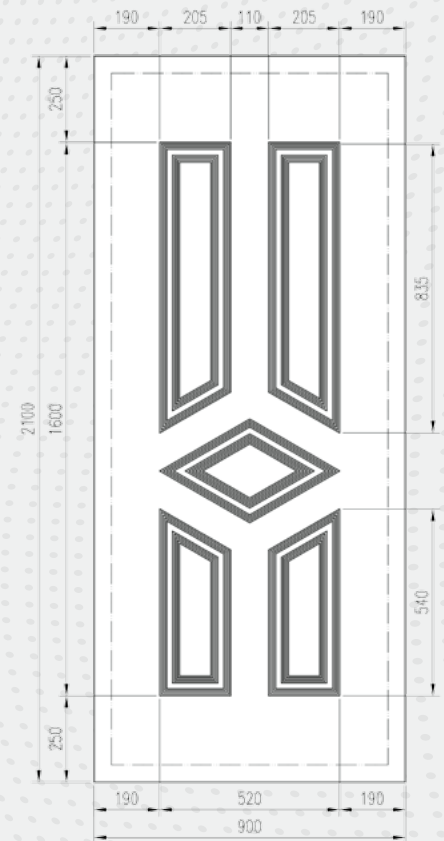

ELVAR



ELVAR



ELVAR
1 v. grande barrotillo blanco

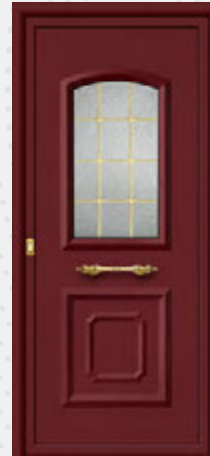

ELVAR
1 v. grande barrotillo oro



ELVAR
1 v. grande sin barrotillo

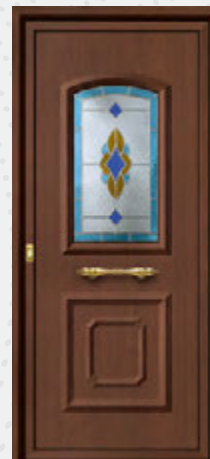

ELVAR
1 v. grande emplomado

- Aluminio
- Pvc
- Lacado Ral
- Anodizado
- Lacado Madera
- Foliado

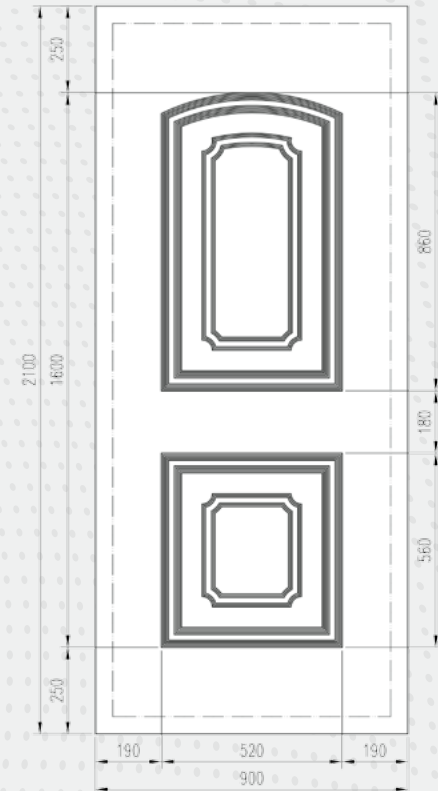

ELVAR



ELVAR
1 v. pequeño barrotillo blanco



ELVAR
1 v. pequeño barrotillo oro



ELVAR
1 v. pequeño sin barrotillo



ELVAR
1 v. pequeño emplomado

- Aluminio
- Pvc
- Lacado Ral
- Anodizado
- Lacado Madera
- Foliado

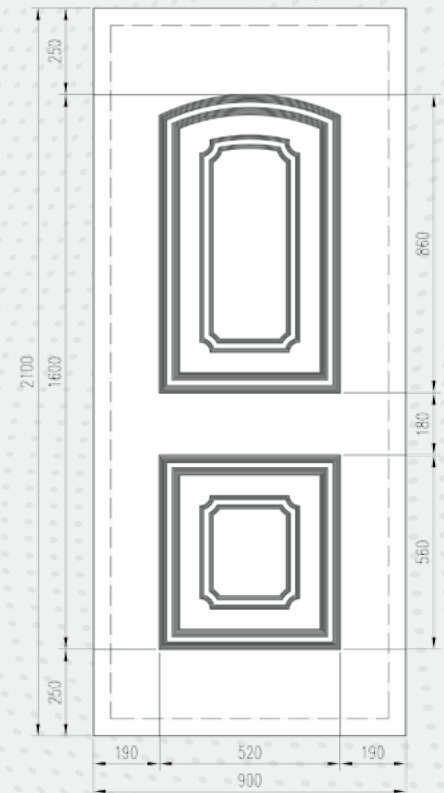

FALCA



FALCA



FALCA
vidrio mate



- Aluminio
- Pvc
- Lacado Ral
- Anodizado
- Lacado Madera
- Foliado

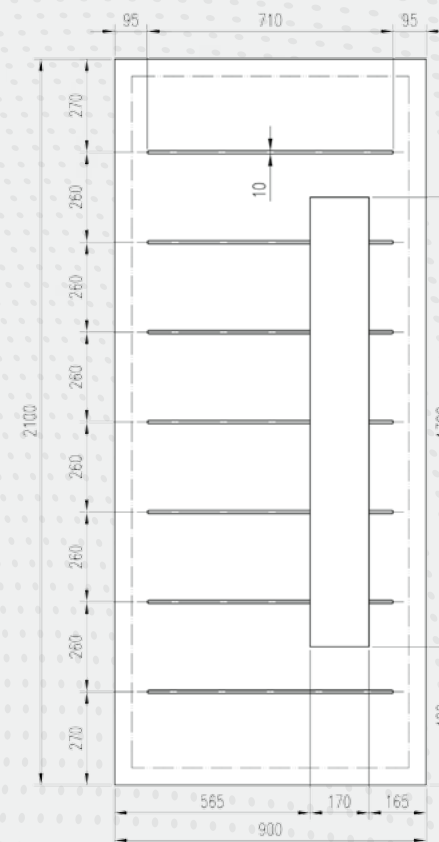

FOQUE



FOQUE



FOQUE
vidrio 4 mate



- Aluminio
- Pvc
- Lacado Ral
- Anodizado
- Lacado Madera
- Foliado

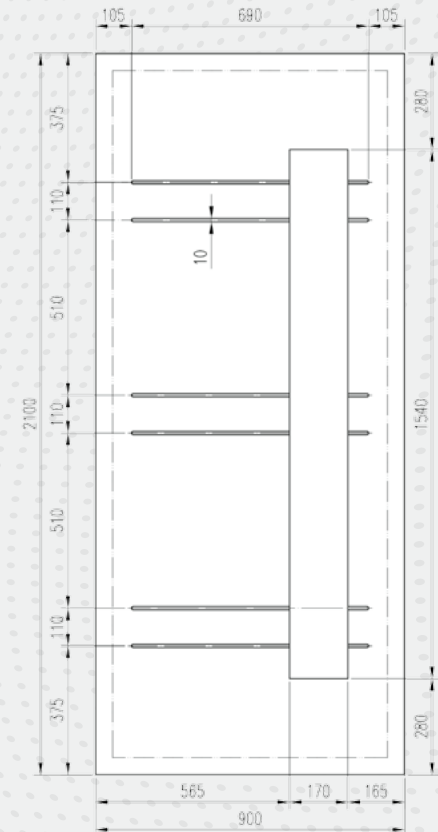

GAZMI



GAZMI

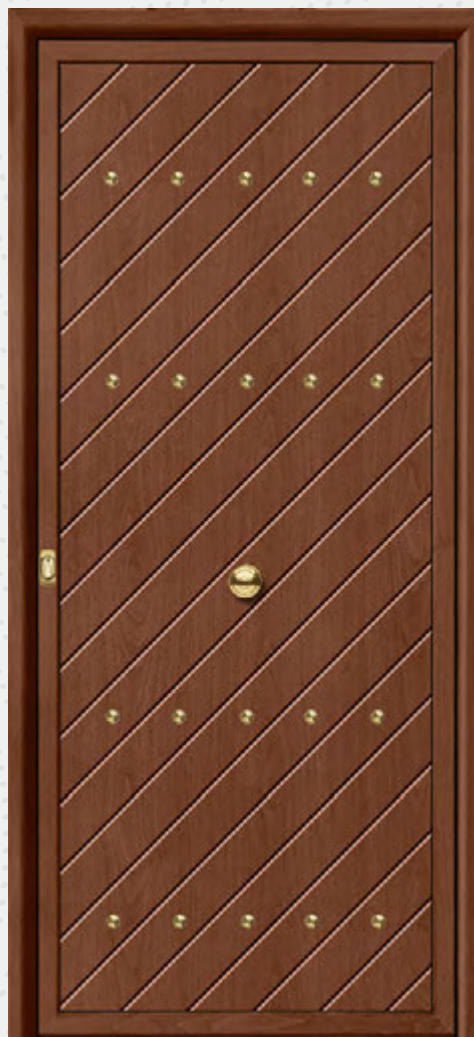

GAZMI RÚSTICO

- Aluminio
- Pvc
- Lacado Ral
- Anodizado
- Lacado Madera
- Foliado

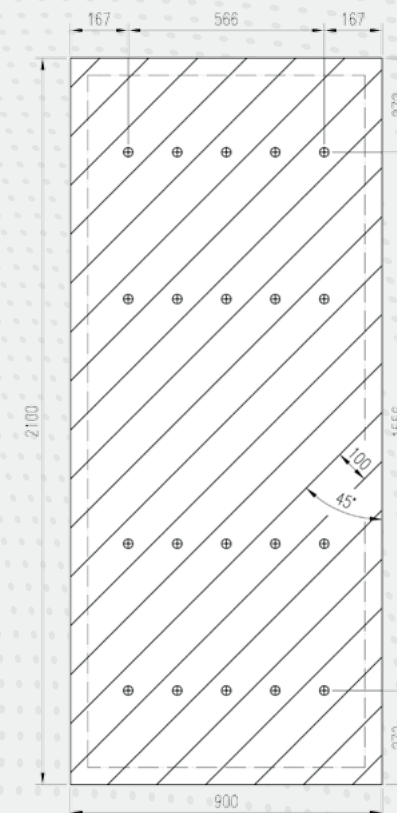

HALGA



HALGA

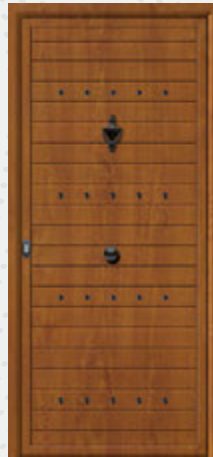

HALGA
rústico

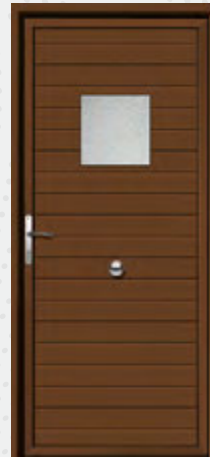

HALGA
V1



HALGA
V2 con moldura

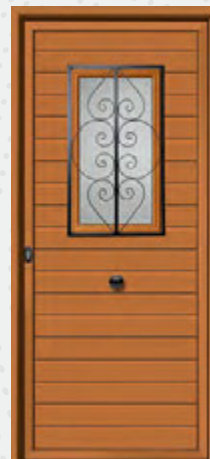

HALGA
V3 con moldura y reja



HALGA
V4

- Aluminio
- Pvc
- Lacado Ral
- Anodizado
- Lacado Madera
- Foliado

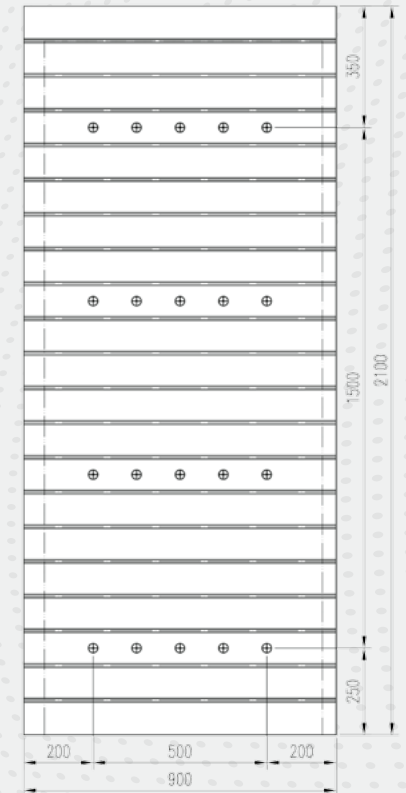

Todos los modelos Halga e Isoca admiten la opción de vidrios tipo V1, V2, V3 y V4, permitiendo también añadir reja y clavos. Se podrá incorporar moldura en lacados de la carta Ral, en acabado Embero y Nogal, tanto foliado como lacado. Consultar combinaciones de vidrios, molduras y rejillas en páginas 44, 45, 46 y 47.

HALGA



HALGA 2R



HALGA 2R
V1 con moldura

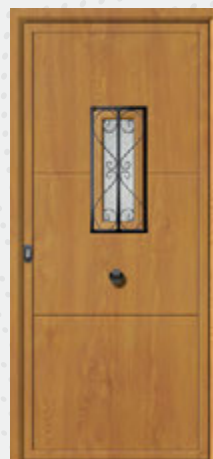

HALGA 2R
V2 con moldura y reja



HALGA 2R
V3



HALGA 2R
V4 con moldura

- Aluminio
- Pvc
- Lacado Ral
- Anodizado
- Lacado Madera
- Foliado

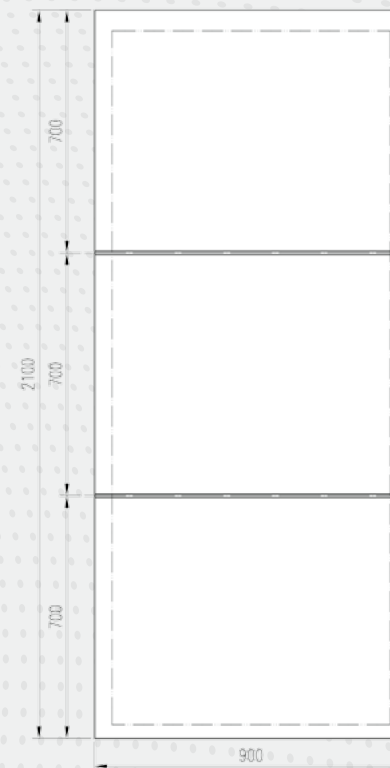

Todos los modelos Halga e Isoca admiten la opción de vidrios tipo V1, V2, V3 y V4, permitiendo también añadir reja y clavos. Se podrá incorporar moldura en lacados de la carta Ral, en acabado Embero y Nogal, tanto foliado como lacado. Consultar combinaciones de vidrios, molduras y rejillas en páginas 44, 45, 46 y 47.

HALGA



HALGA 2X2

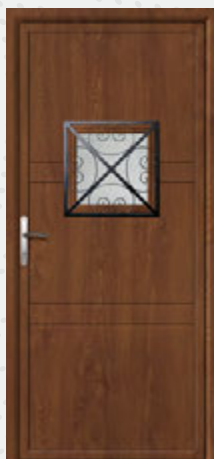

HALGA 2X2
V1 con moldura y reja



HALGA 2X2
V2 con moldura



HALGA 2X2
V3



HALGA 2X2
V4

- Aluminio
- Pvc
- Lacado Ral
- Anodizado
- Lacado Madera
- Foliado

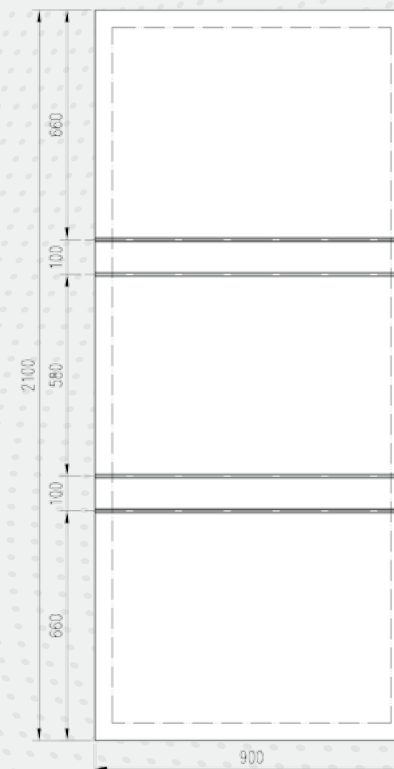

Todos los modelos Halga e Isoca admiten la opción de vidrios tipo V1, V2, V3 y V4, permitiendo también añadir reja y clavos. Se podrá incorporar moldura en lacados de la carta Ral, en acabado Embero y Nogal, tanto foliado como lacado. Consultar combinaciones de vidrios, molduras y rejas en páginas 44, 45, 46 y 47.

HALGA



HALGA 3R



HALGA 3R
V1



HALGA 3R
V2 con moldura



HALGA 3R
V3 con moldura y reja



HALGA 3R
V4

- Aluminio
- Pvc
- Lacado Ral
- Anodizado
- Lacado Madera
- Foliado



Todos los modelos Halga e Isoca admiten la opción de vidrios tipo V1, V2, V3 y V4, permitiendo también añadir reja y clavos. Se podrá incorporar moldura en lacados de la carta Ral, en acabado Embero y Nogal, tanto foliado como lacado. Consultar combinaciones de vidrios, molduras y rejas en páginas 44, 45, 46 y 47.

HALGA



HALGA 3X2



HALGA 3X2
V1



HALGA 3X2
V2 con moldura



HALGA 3X2
V3



HALGA 3X2
V4 con moldura y reja

- Aluminio
- Pvc
- Lacado Ral
- Anodizado
- Lacado Madera
- Foliado

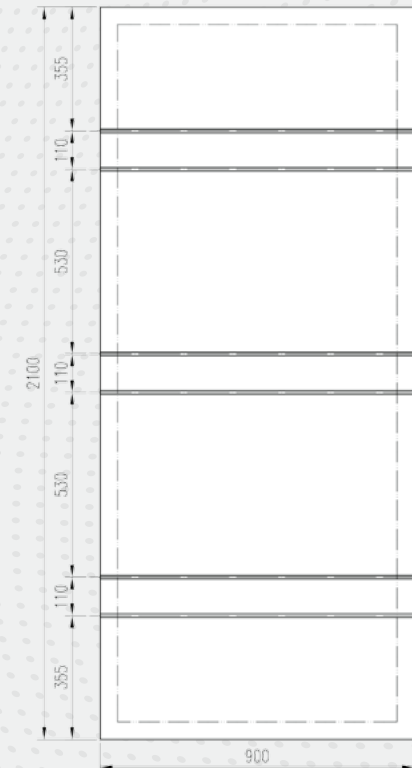

Todos los modelos Halga e Isoca admiten la opción de vidrios tipo V1, V2, V3 y V4, permitiendo también añadir reja y clavos. Se podrá incorporar moldura en lacados de la carta Ral, en acabado Embero y Nogal, tanto foliado como lacado. Consultar combinaciones de vidrios, molduras y rejas en páginas 44, 45, 46 y 47.

HALGA



HALGA 4R



HALGA 4R
V1



HALGA 4R
V2 con moldura

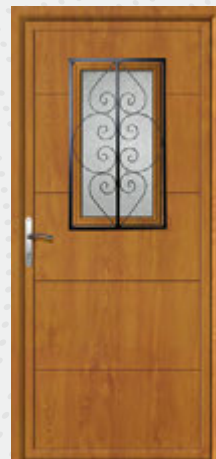

HALGA 4R
V3 con moldura y reja



HALGA 4R
V4

- Aluminio
- Pvc
- Lacado Ral
- Anodizado
- Lacado Madera
- Foliado



Todos los modelos Halga e Isoca admiten la opción de vidrios tipo V1, V2, V3 y V4, permitiendo también añadir reja y clavos. Se podrá incorporar moldura en lacados de la carta Ral, en acabado Embero y Nogal, tanto foliado como lacado. Consultar combinaciones de vidrios, molduras y rejas en páginas 44, 45, 46 y 47.

HALGA



HALGA 6R

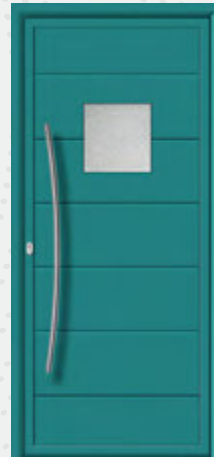

HALGA 6R
V1

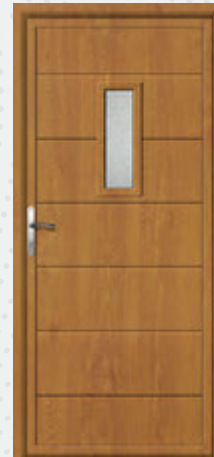

HALGA 6R
V2 con moldura

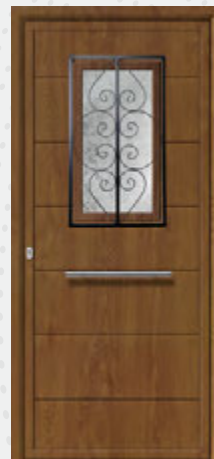

HALGA 6R
V3 con moldura y reja



HALGA 6R
V4

- Aluminio
- Pvc
- Lacado Ral
- Anodizado
- Lacado Madera
- Foliado



Todos los modelos Halga e Isoca admiten la opción de vidrios tipo V1, V2, V3 y V4, permitiendo también añadir reja y clavos. Se podrá incorporar moldura en lacados de la carta Ral, en acabado Embero y Nogal, tanto foliado como lacado. Consultar combinaciones de vidrios, molduras y rejas en páginas 44, 45, 46 y 47.

HALGA



HALGA 8R



HALGA 8R
V1 con moldura

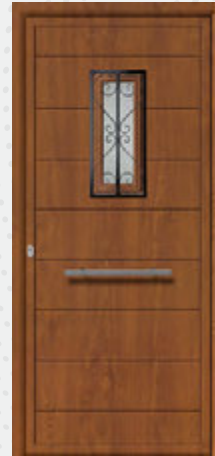

HALGA 8R
V2 con moldura y reja



HALGA 8R
V3



HALGA 8R
V4

- Aluminio
 - Pvc
-
- Lacado Ral
 - Anodizado
 - Lacado Madera
 - Foliado

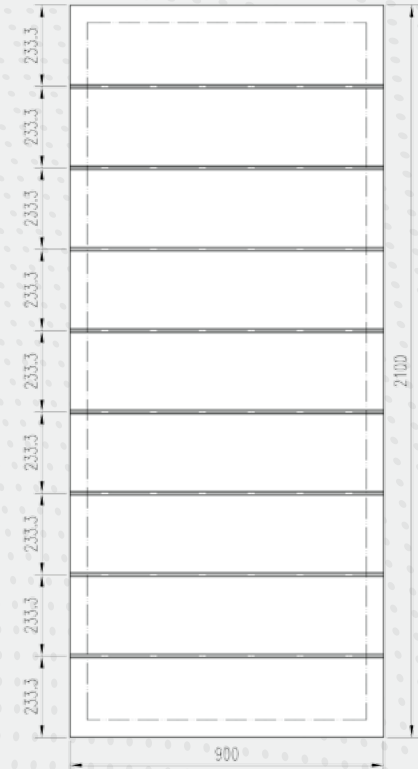

Todos los modelos Halga e Isoca admiten la opción de vidrios tipo V1, V2, V3 y V4, permitiendo también añadir reja y clavos. Se podrá incorporar moldura en lacados de la carta Ral, en acabado Embero y Nogal, tanto foliado como lacado. Consultar combinaciones de vidrios, molduras y rejillas en páginas 44, 45, 46 y 47.

ISOCA



ISOCA

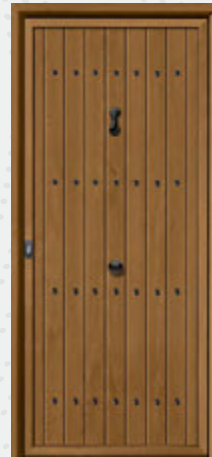

ISOCA
rústico



ISOCA
V1 con moldura

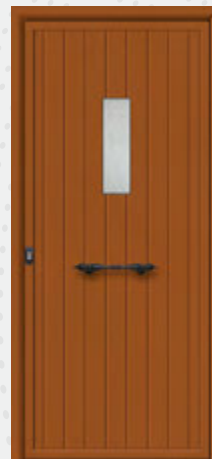

ISOCA
V2

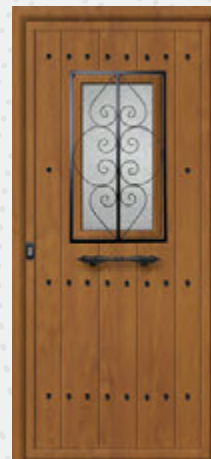

ISOCA
rústico V3 c/moldura y reja



ISOCA
V4 con moldura y reja

- Aluminio
- Pvc
- Lacado Ral
- Anodizado
- Lacado Madera
- Foliado

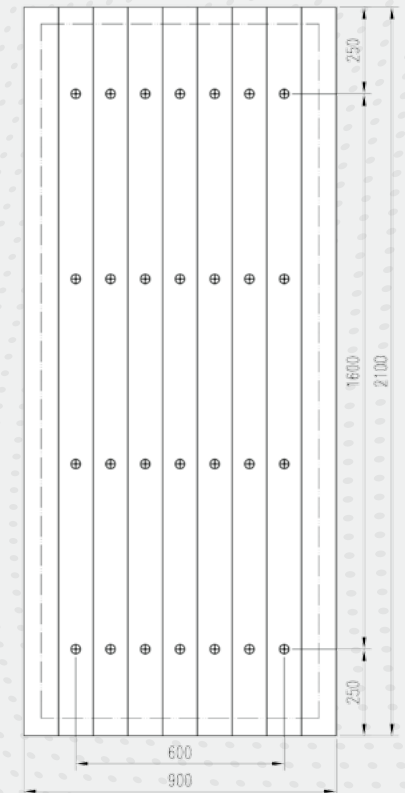

Todos los modelos Halga e Isoca admiten la opción de vidrios tipo V1, V2, V3 y V4, permitiendo también añadir reja y clavos. Se podrá incorporar moldura en lacados de la carta Ral, en acabado Embero y Nogal, tanto foliado como lacado. Consultar combinaciones de vidrios, molduras y rejas en páginas 44, 45, 46 y 47.

ISOCA



ISOCA 2R



ISOCA 2R
V1 con moldura



ISOCA 2R
V2



ISOCA 2R
V3 con moldura y reja



ISOCA 2R
V4

- Aluminio
- Pvc
- Lacado Ral
- Anodizado
- Lacado Madera
- Foliado

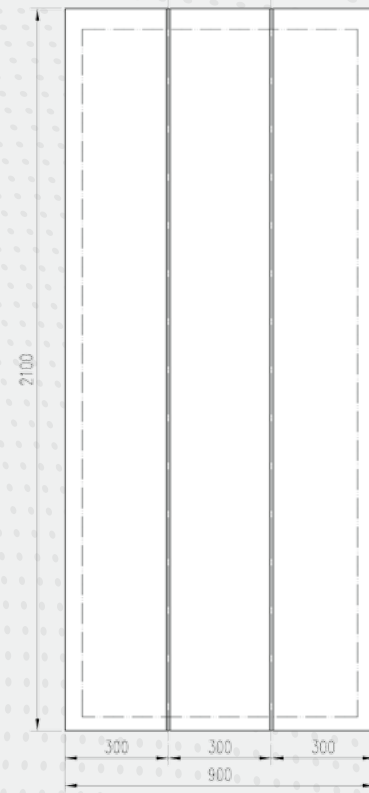

Todos los modelos Halga e Isoca admiten la opción de vidrios tipo V1, V2, V3 y V4, permitiendo también añadir reja y clavos. Se podrá incorporar moldura en lacados de la carta Ral, en acabado Embero y Nogal, tanto foliado como lacado. Consultar combinaciones de vidrios, molduras y rejas en páginas 44, 45, 46 y 47.

ISOCA



ISOCA 3R



ISOCA 3R
V4

- Aluminio
- Pvc
- Lacado Ral
- Anodizado
- Lacado Madera
- Foliado

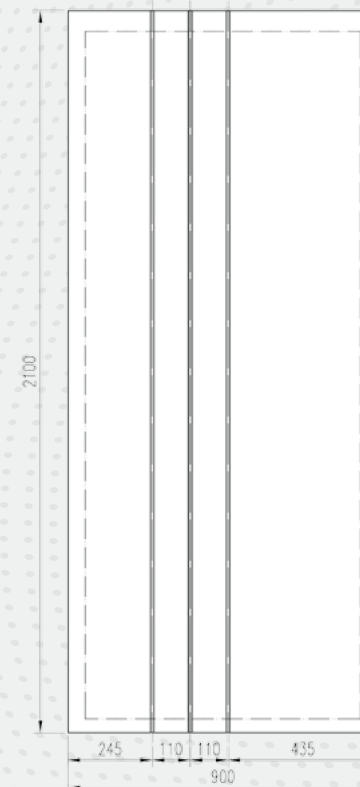

Todos los modelos Halga e Isoca admiten la opción de vidrios tipo V1, V2, V3 y V4, permitiendo también añadir reja y clavos. Se podrá incorporar moldura en lacados de la carta Ral, en acabado Embero y Nogal, tanto foliado como lacado. Consultar combinaciones de vidrios, molduras y rejas en páginas 44, 45, 46 y 47.

ISOCA



ISOCA 3R 200



ISOCA 3R 200
V2



ISOCA 3R 200
V2 con moldura



ISOCA 3R 200
V3



ISOCA 3R 200
V4 con moldura y reja

- Aluminio
- Pvc
- Lacado Ral
- Anodizado
- Lacado Madera
- Foliado

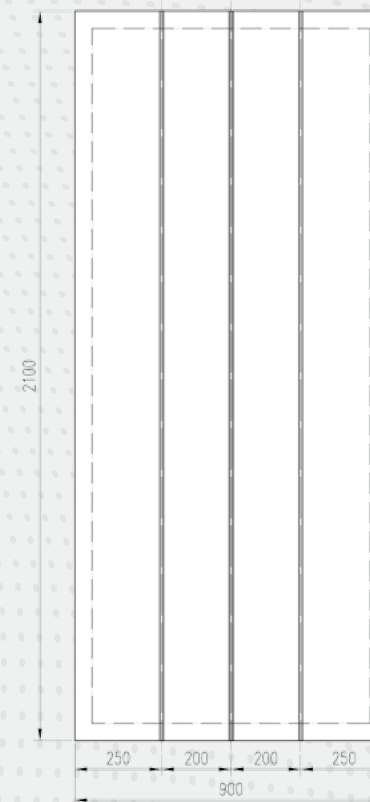

Todos los modelos Halga e Isoca admiten la opción de vidrios tipo V1, V2, V3 y V4, permitiendo también añadir reja y clavos. Se podrá incorporar moldura en lacados de la carta Ral, en acabado Embero y Nogal, tanto foliado como lacado. Consultar combinaciones de vidrios, molduras y rejas en páginas 44, 45, 46 y 47.

ISOCA



ISOCA 4R



ISOCA 4R
V1



ISOCA 4R
V2 con moldura

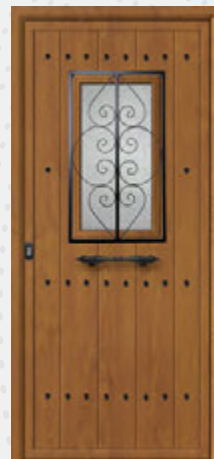

ISOCA 4R
V3 rústico c/moldura y reja



ISOCA 4R
V4

- Aluminio
- Pvc
- Lacado Ral
- Anodizado
- Lacado Madera
- Foliado

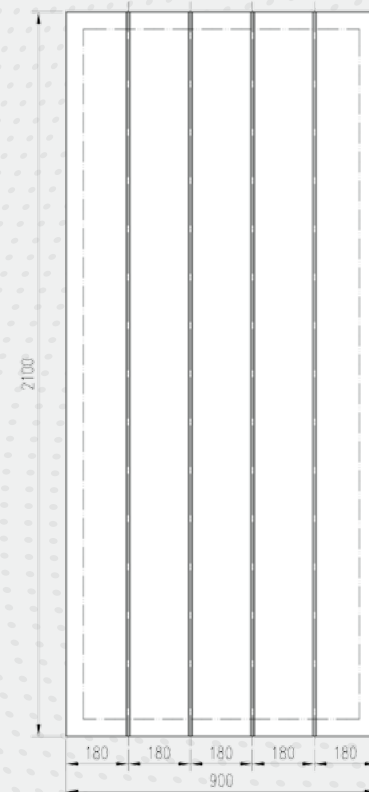

Todos los modelos Halga e Isoca admiten la opción de vidrios tipo V1, V2, V3 y V4, permitiendo también añadir reja y clavos. Se podrá incorporar moldura en lacados de la carta Ral, en acabado Embero y Nogal, tanto foliado como lacado. Consultar combinaciones de vidrios, molduras y rejas en páginas 44, 45, 46 y 47.

JEREZ



JEREZ



JEREZ
1 vidrio barrotillo blanco



JEREZ
1 vidrio barrotillo oro



JEREZ
1 vidrio sin barrotillo



JEREZ
1 vidrio emplomado

- Aluminio
- Pvc
- Lacado Ral
- Anodizado
- Lacado Madera
- Foliado

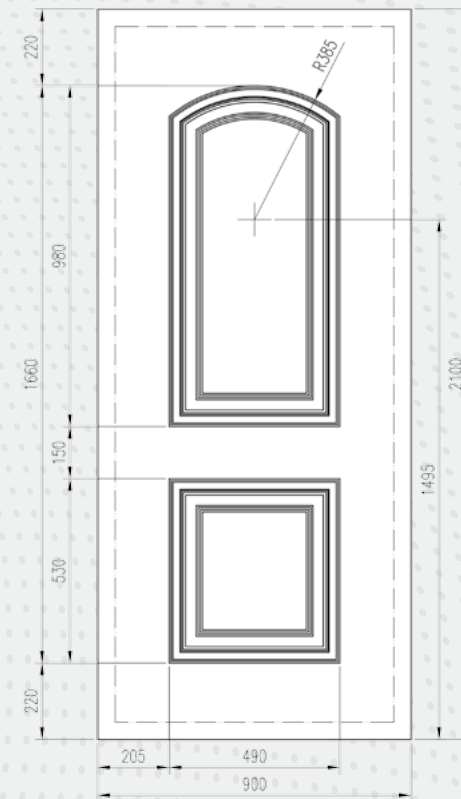

JEREZ



JEREZ
Cornisa 1



JEREZ
Cornisa 2

- Aluminio
- Pvc
- Lacado Ral
- Anodizado
- Lacado Madera
- Foliado

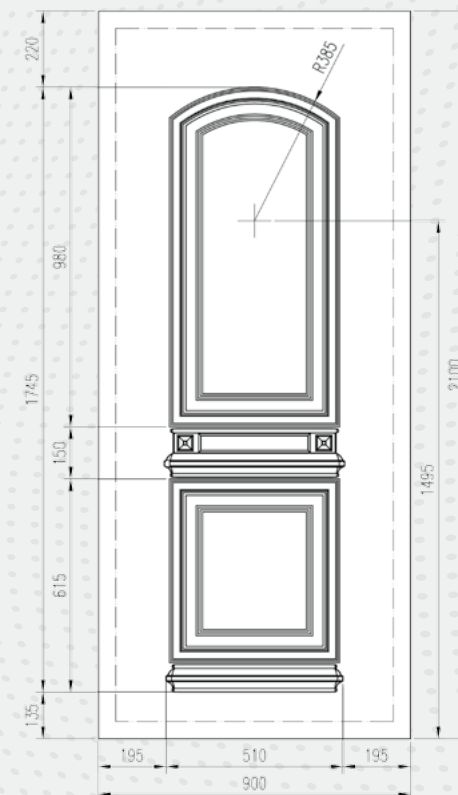

KORSA



KORSA



KORSA
1 vidrio barrotillo blanco

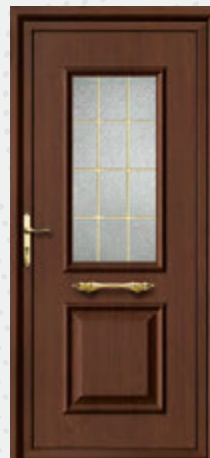

KORSA
1 vidrio barrotillo oro



KORSA
1 vidrio sin barrotillo



KORSA
1 vidrio emplomado

- Aluminio
- Pvc
- Lacado Ral
- Anodizado
- Lacado Madera
- Foliado

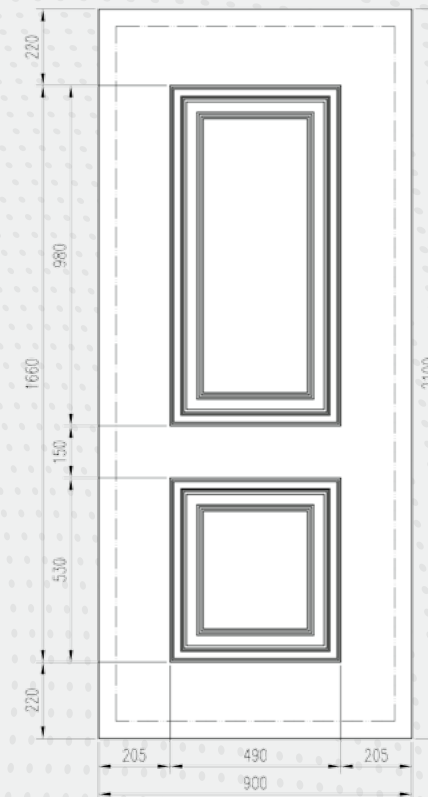

KORSA



KORSA
Cornisa 1



KORSA
Cornisa 2



KORSA
Cornisa 3

- Aluminio
- Pvc
- Lacado Ral
- Anodizado
- Lacado Madera
- Foliado

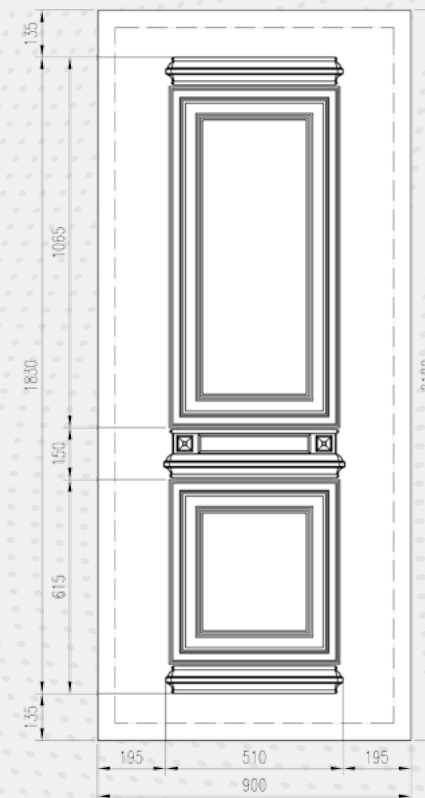

LEYNE



LEYNE



LEYNE
1 vidrio



LEYNE
3 vidrios

- Aluminio
- Pvc
- Lacado Ral
- Anodizado
- Lacado Madera
- Foliado

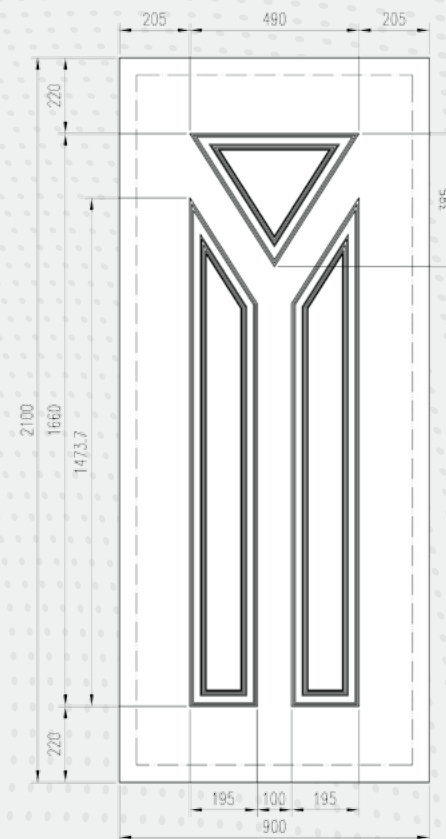

MALMO



MALMO



MALMO
2 vidrios barrotillo blanco



MALMO
2 vidrios barrotillo oro



MALMO
2 vidrios sin barrotillo

- Aluminio
- Pvc
- Lacado Ral
- Anodizado
- Lacado Madera
- Foliado

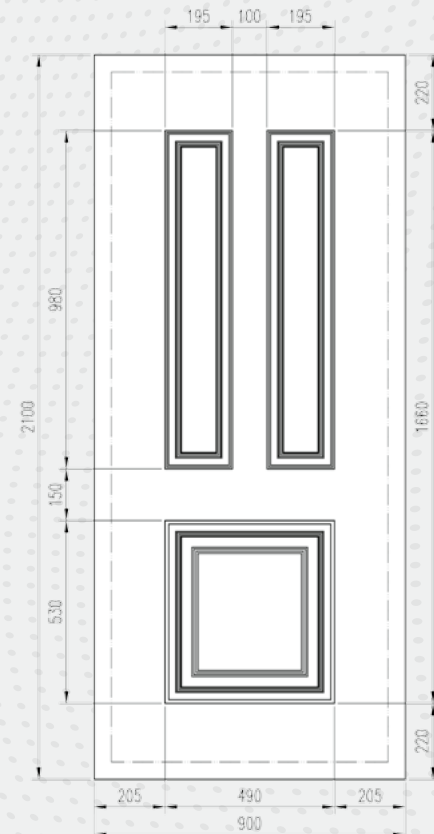

NOLSO



NOLSO



NOLSO
1 vidrio barrotillo oro



NOLSO
2 vidrios sin barrotillo

- Aluminio
- Pvc
- Lacado Ral
- Anodizado
- Lacado Madera
- Foliado

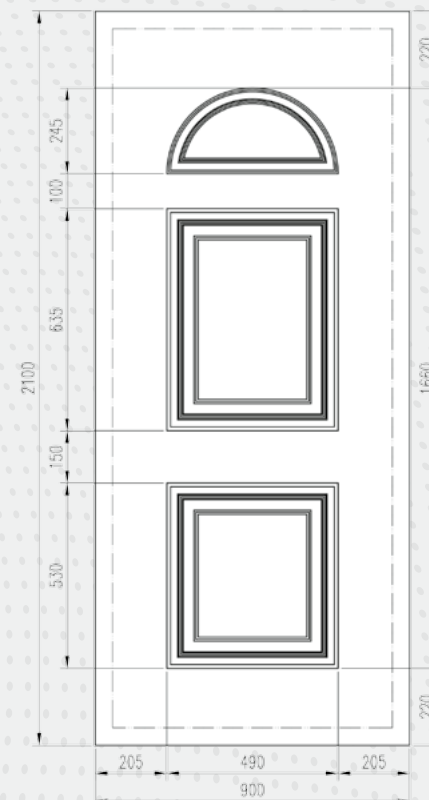

OLVIA



OLVIA



OLVIA
1 vidrio sin barrotillo



OLVIA
3 vidrios barrotillo oro



OLVIA
5 vidrios barrotillo oro

- Aluminio
- Pvc
- Lacado Ral
- Anodizado
- Lacado Madera
- Foliado

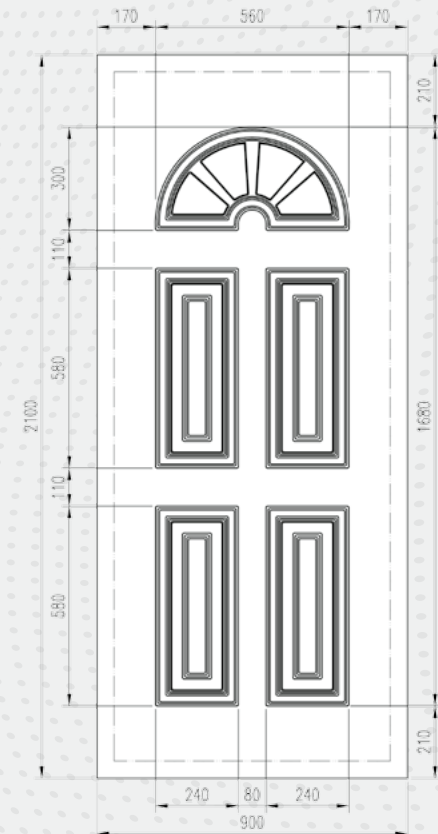

PERLA



PERLA



PERLA
1 vidrio barrotillo blanco



PERLA
1 vidrio sin barrotillo

- Aluminio
- Pvc
- Lacado Ral
- Anodizado
- Lacado Madera
- Foliado

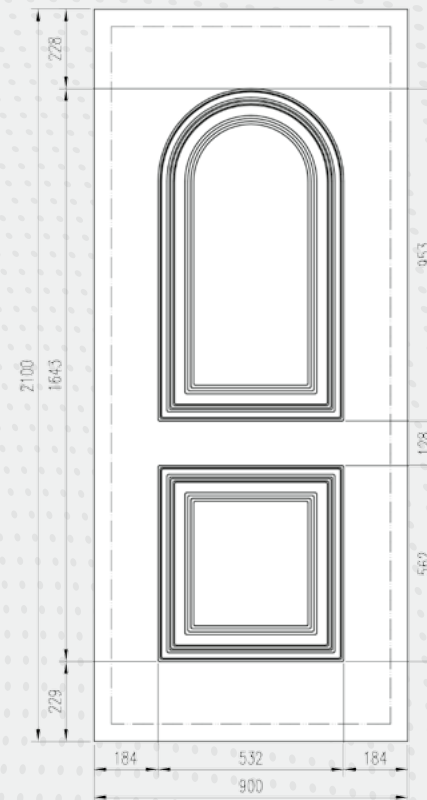

SAGRA



SAGRA



SAGRA
2 vidrios sin barrotillo



SAGRA
4 vidrios sin barrotillo

- Aluminio
- Pvc
- Lacado Ral
- Anodizado
- Lacado Madera
- Foliado

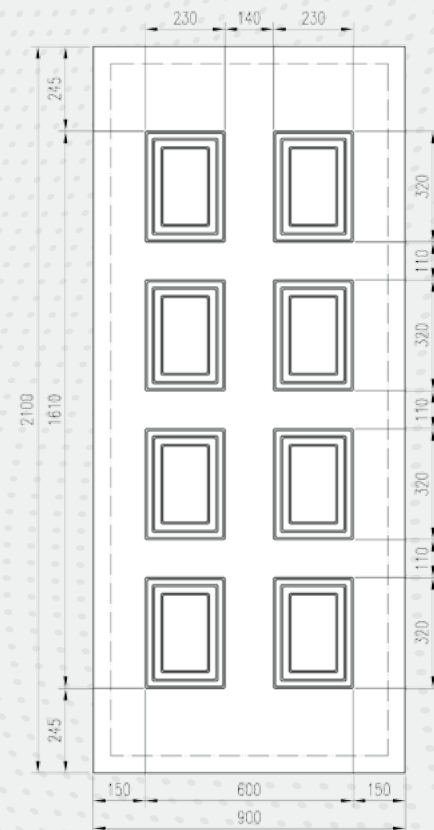

TRIMO



TRIMO



TRIMO
4 vidrios sin barrotillo

- Aluminio
- Pvc
- Lacado Ral
- Anodizado
- Lacado Madera
- Foliado

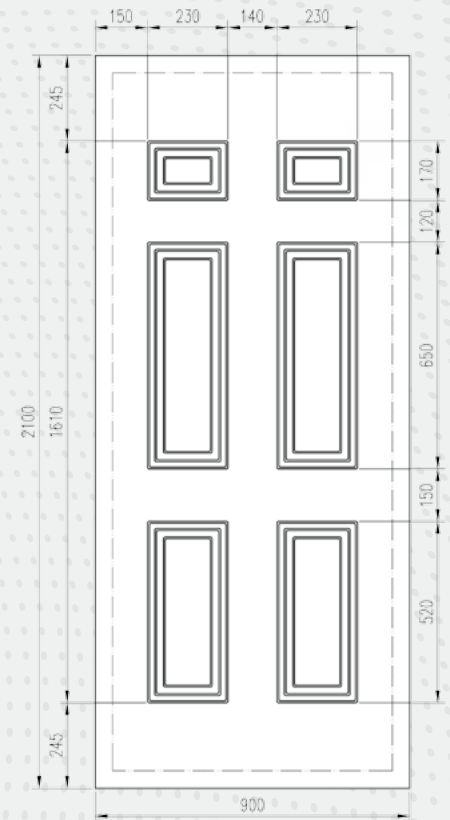

URBAN



URBAN



URBAN
1 vidrio sin barrotillo

- Aluminio
- Pvc
- Lacado Ral
- Anodizado
- Lacado Madera
- Foliado

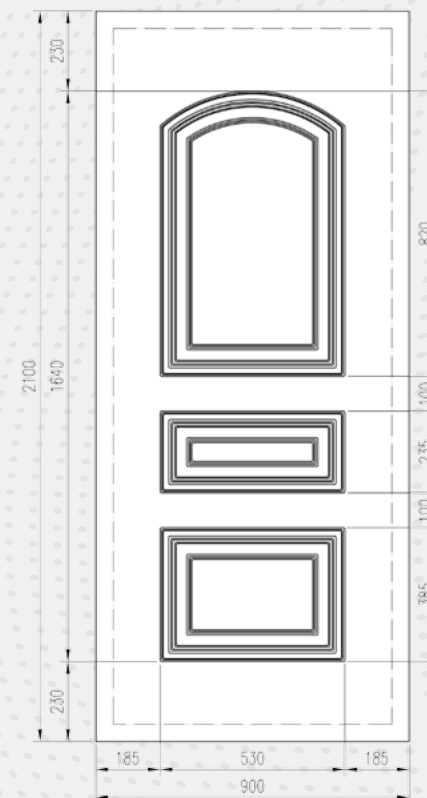

VESTA



VESTA



VESTA
2 vidrios sin barrotillo

- Aluminio
- Pvc
- Lacado Ral
- Anodizado
- Lacado Madera
- Foliado

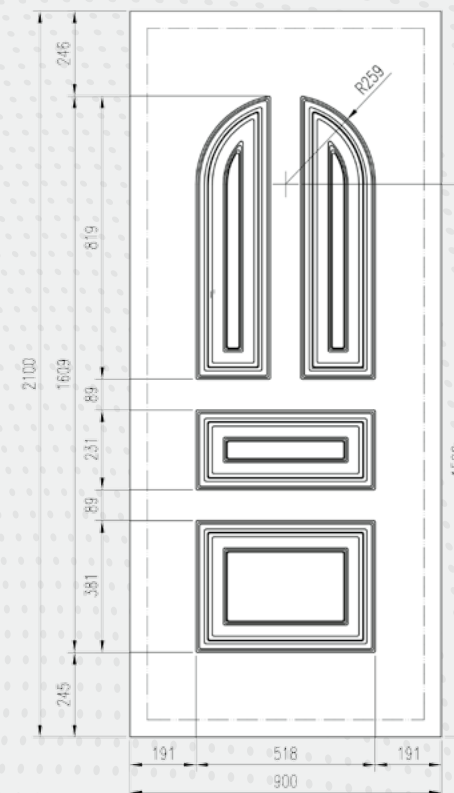

TERCIOS



TERCIO CURVO



TERCIO KORSA



TERCIO RECTO

- Aluminio
- Pvc
- Lacado Ral
- Anodizado
- Lacado Madera
- Foliado

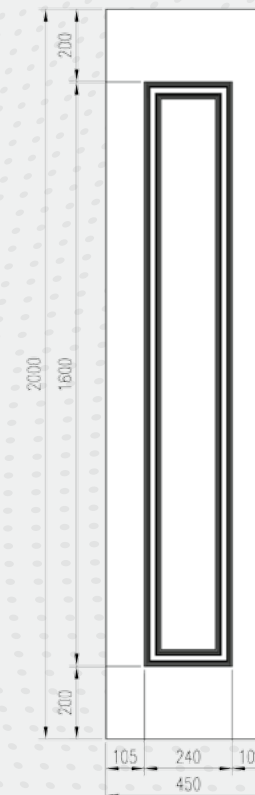
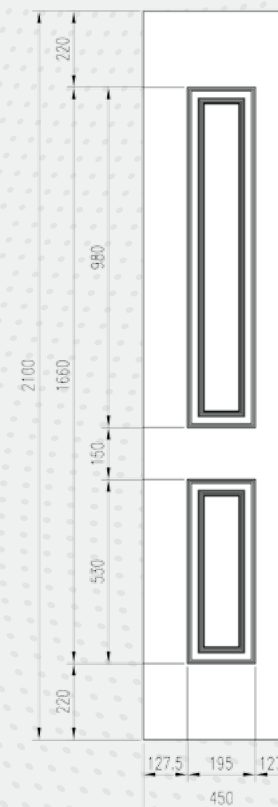
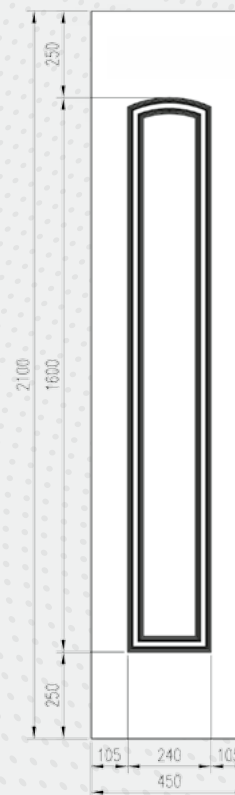



LISO V1



LISO V1
con moldura

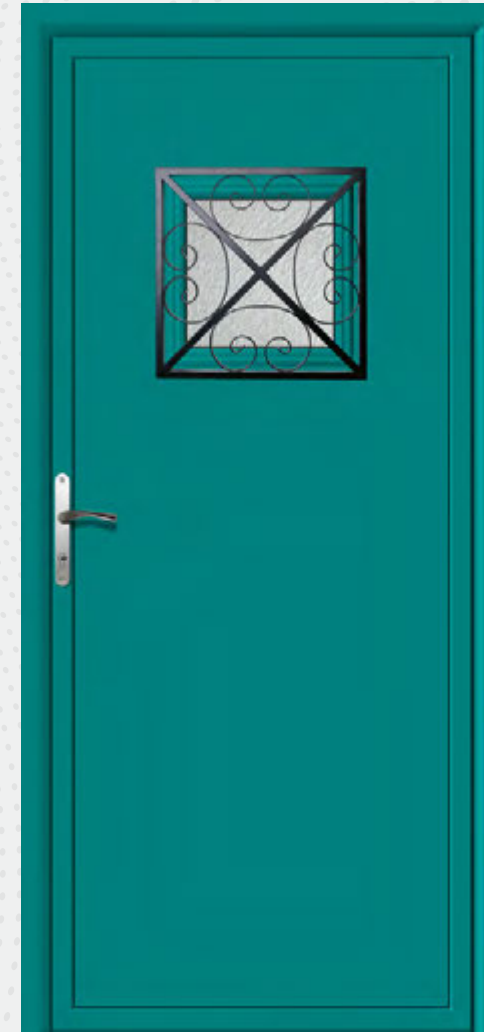

LISO V1
con moldura y reja

- Aluminio
- Pvc
- Lacado Ral
- Anodizado
- Lacado Madera
- Foliado

Posibilidad de combinación de todos estos modelos con Halga e Isoca.



LISO V2



LISO V2
con moldura



LISO V2
con moldura y reja

- | | |
|----------------------------------|---------------|
| <input checked="" type="radio"/> | Aluminio |
| <input type="radio"/> | Pvc |
| <input checked="" type="radio"/> | Lacado Ral |
| <input checked="" type="radio"/> | Anodizado |
| <input checked="" type="radio"/> | Lacado Madera |
| <input checked="" type="radio"/> | Foliado |

Posibilidad de combinación de todos estos modelos con Halga e Isoca.



LISO V3



LISO V3
con moldura



LISO V3
con moldura y reja

- | | |
|----------------------------------|---------------|
| <input checked="" type="radio"/> | Aluminio |
| <input type="radio"/> | Pvc |
| <input checked="" type="radio"/> | Lacado Ral |
| <input checked="" type="radio"/> | Anodizado |
| <input checked="" type="radio"/> | Lacado Madera |
| <input checked="" type="radio"/> | Foliado |

Posibilidad de combinación de todos estos modelos con Halga e Isoca.



LISO V4



LISO V4
con moldura



LISO V4
con moldura y reja

- | | |
|----------------------------------|---------------|
| <input checked="" type="radio"/> | Aluminio |
| <input type="radio"/> | Pvc |
| <input checked="" type="radio"/> | Lacado Ral |
| <input checked="" type="radio"/> | Anodizado |
| <input checked="" type="radio"/> | Lacado Madera |
| <input checked="" type="radio"/> | Foliado |

Posibilidad de combinación de todos estos modelos con Halga e Isoca.

CASTELLANO



CASTELLANO 1

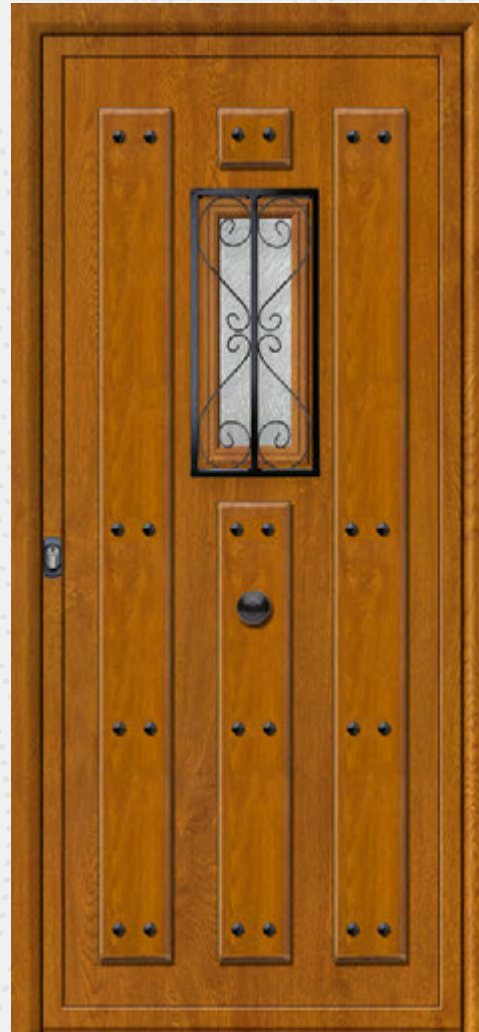

CASTELLANO 1
con moldura y reja

FOLIADO
solamente en acabados
R. Embero y R. Nogal.

- Aluminio
- Pvc

LACADO MADERA
solamente en acabados
Embero y Nogal.

- Lacado Ral
- Anodizado
- Lacado Madera
- Foliado

PANEL ESTÁNDAR
Lamas solo cara exterior
interior liso.

Posibilidad con y sin clavos
(ver clavos en pag 154)

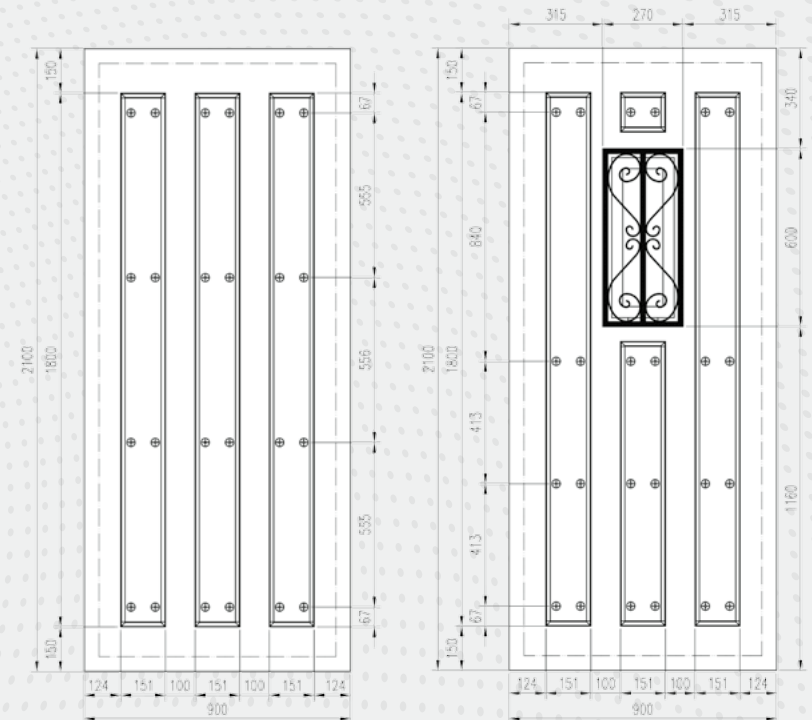

CASTELLANO



CASTELLANO 2



CASTELLANO 3

FOLIADO
solamente en acabados
R. Embero y R. Nogal.

LACADO MADERA
solamente en acabados
Embero y Nogal.

PANEL ESTÁNDAR
Lamas solo cara exterior
interior liso.

Posibilidad con y sin clavos
(ver clavos en pag 154)

<input checked="" type="radio"/>	Aluminio
<input type="radio"/>	Pvc
<input checked="" type="radio"/>	Lacado Ral
<input type="radio"/>	Anodizado
<input checked="" type="radio"/>	Lacado Madera
<input checked="" type="radio"/>	Foliado

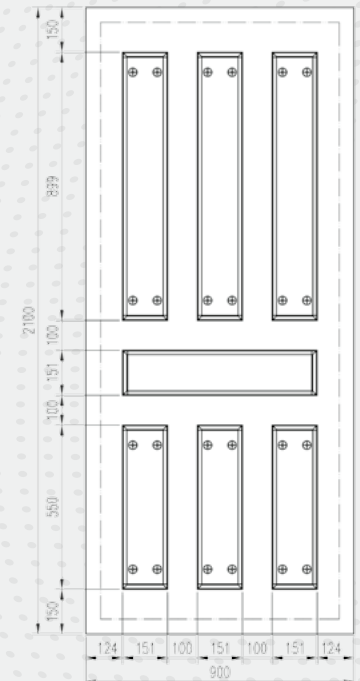
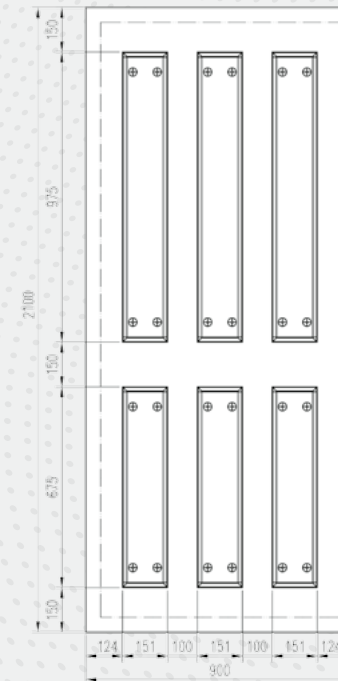





SEDUCCIÓN

NÚCLEOS

XPS: $U = 1,57 \text{ W/m}^2 \text{ }^\circ\text{K}$

ALMA MIXTA: $U = 2,03 \text{ W/m}^2 \text{ }^\circ\text{K}$

TABLERO MARINO: $U = 2,77 \text{ W/m}^2 \text{ }^\circ\text{K}$

OPCIONES

Refuerzo Chapa Aluminio

Blindaje Chapa Acero

MEDIDAS FABRICACIÓN

2000 x 800

2100 x 900

ACABADOS

LACADOS RAL

ANODIZADO

LACADO MADERA

FOLIADO

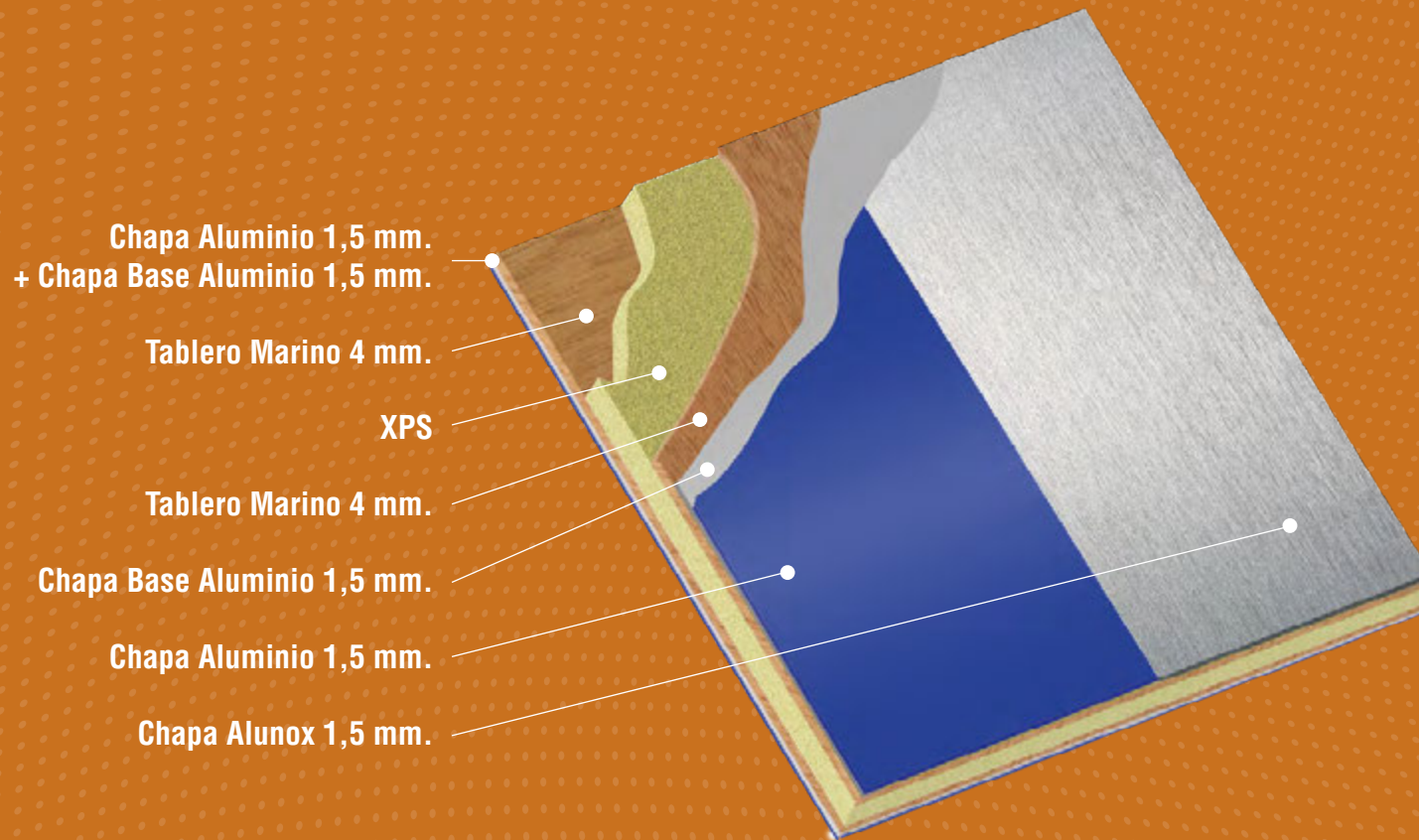

Vista de todos los modelos: Exterior.

AIDA



AIDA
2 vidrios mate



AIDA
2 vidrios fusing

- Aluminio
- Pvc
- Lacado Ral
- Anodizado
- Lacado Madera
- Foliado

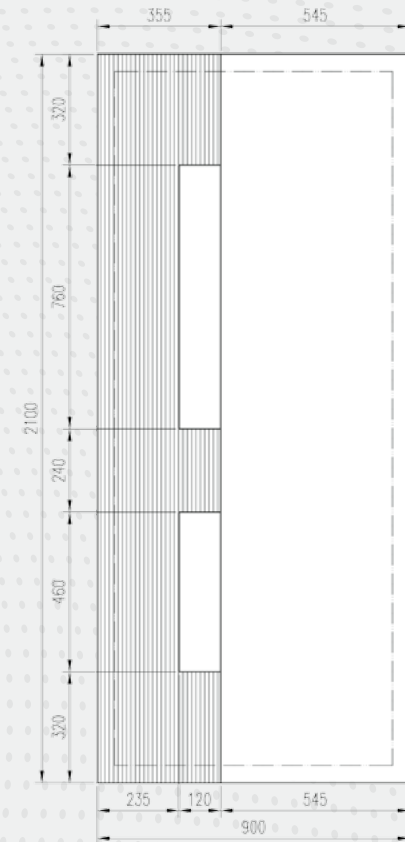

ALBA



ALBA
4 vidrios mate



ALBA
4 vidrios fusing

- Aluminio
- Pvc
- Lacado Ral
- Anodizado
- Lacado Madera
- Foliado

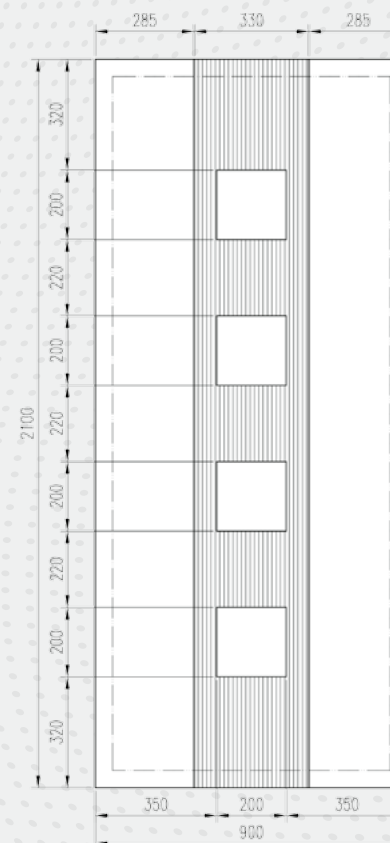

CARLA



CARLA
3 vidrios mate



CARLA
3 vidrios fusing

- Aluminio
- Pvc
- Lacado Ral
- Anodizado
- Lacado Madera
- Foliado

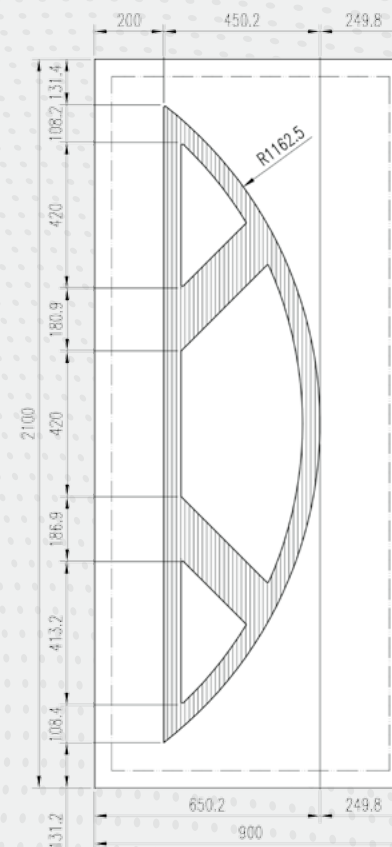

CELIA



CELIA
1 vidrio mate



CELIA
1 vidrio fusing

- Aluminio
- Pvc
- Lacado Ral
- Anodizado
- Lacado Madera
- Foliado

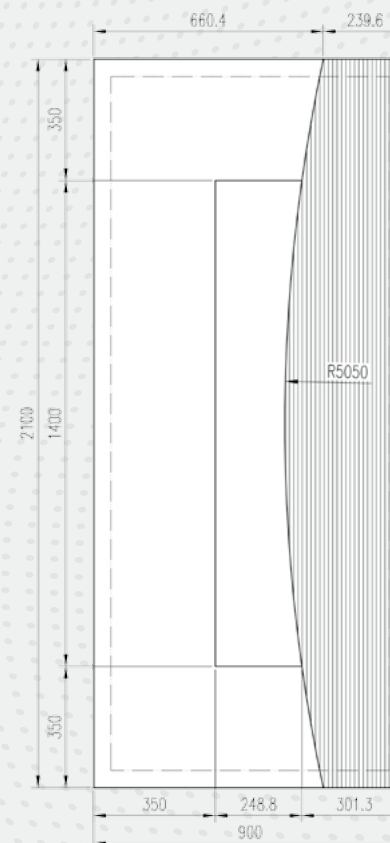

CLARA



CLARA
6 vidrios mate



CLARA
6 vidrios fusing

- Aluminio
- Pvc
- Lacado Ral
- Anodizado
- Lacado Madera
- Foliado

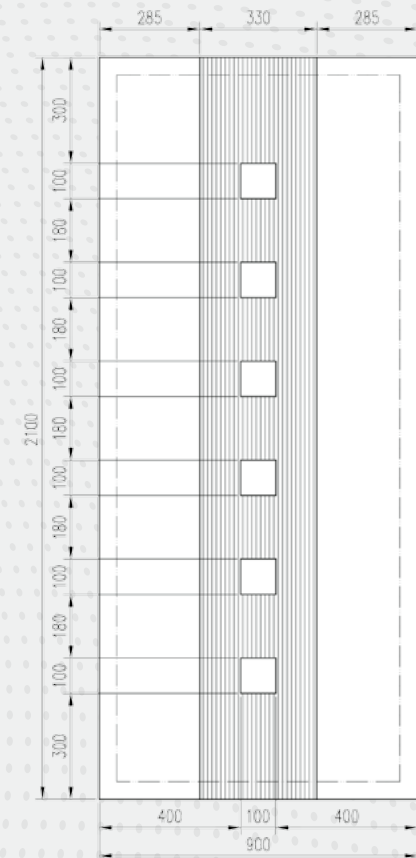

CLAUDIA



CLAUDIA
3 vidrios mate



CLAUDIA
3 vidrios fusing

- Aluminio
- Pvc
- Lacado Ral
- Anodizado
- Lacado Madera
- Foliado

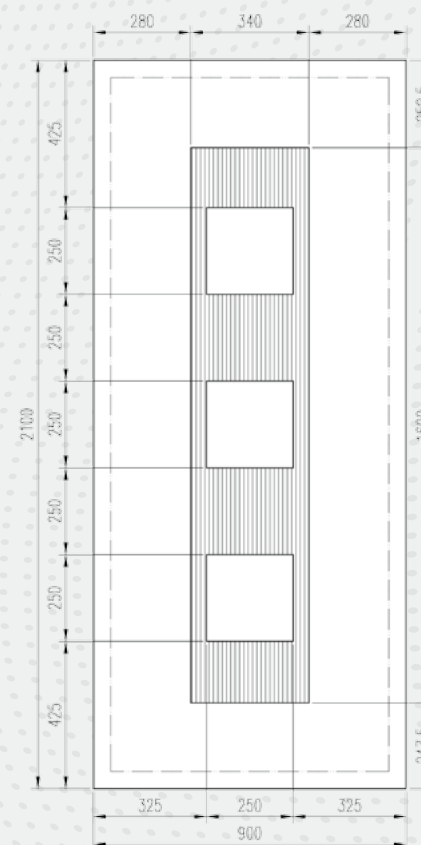

ELENA



ELENA
2 vidrios mate



ELENA
2 vidrios fussing

- Aluminio
- Pvc
- Lacado Ral
- Anodizado
- Lacado Madera
- Foliado

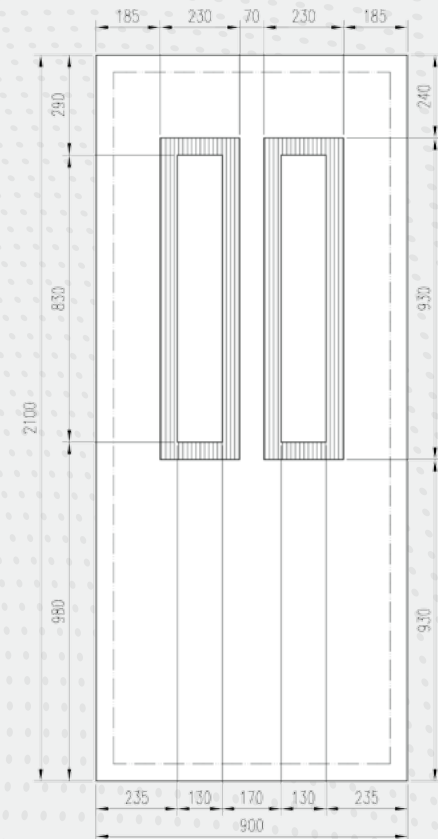

GEMMA



GEMMA
2 vidrios mate



GEMMA
2 vidrios fusing

- Aluminio
- Pvc
- Lacado Ral
- Anodizado
- Lacado Madera
- Foliado

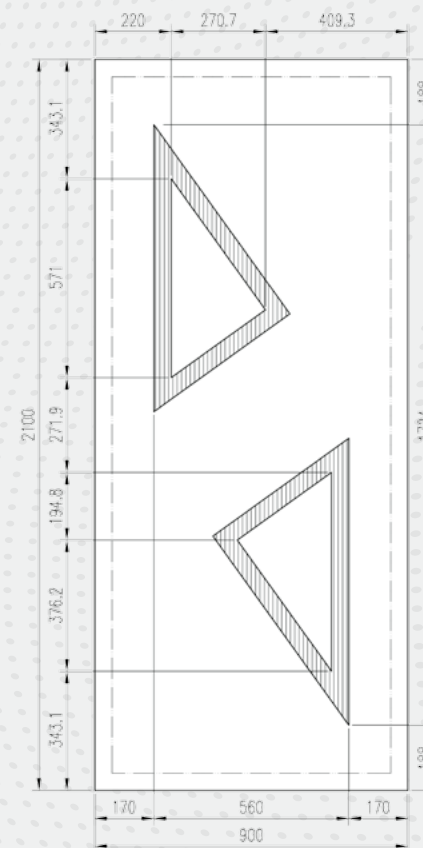

JULIA



JULIA
1 vidrio mate



JULIA
1 vidrio fusing

- Aluminio
- Pvc
- Lacado Ral
- Anodizado
- Lacado Madera
- Foliado

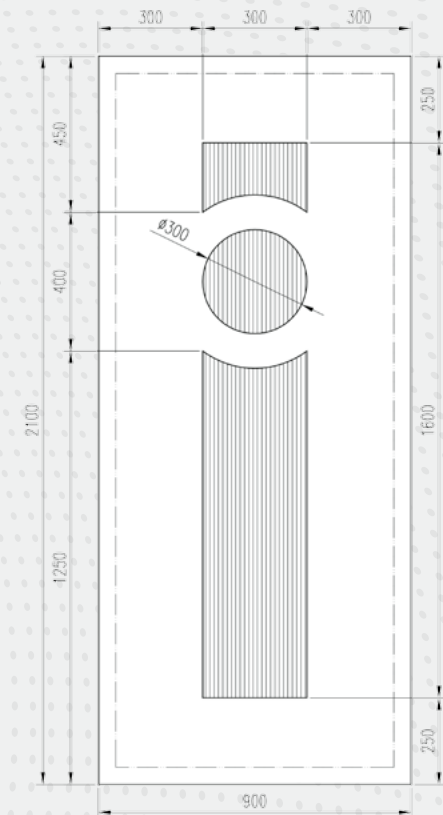

LAURA



LAURA
1 vidrio mate



LAURA
1 vidrio fusing

- Aluminio
- Pvc
- Lacado Ral
- Anodizado
- Lacado Madera
- Foliado

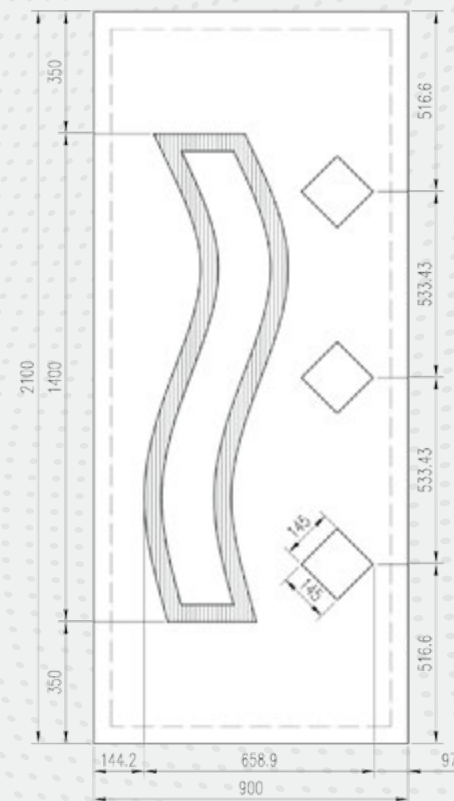

MARÍA



MARÍA
3 vidrios mate



MARÍA
3 vidrios fusing

- Aluminio
- Pvc
- Lacado Ral
- Anodizado
- Lacado Madera
- Foliado

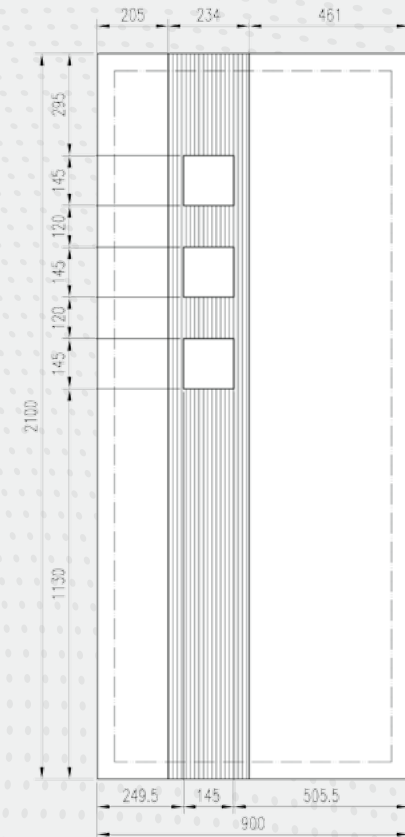

MARTA



MARTA
4 vidrios mate



MARTA
4 vidrios fusing

- Aluminio
- Pvc
- Lacado Ral
- Anodizado
- Lacado Madera
- Foliado

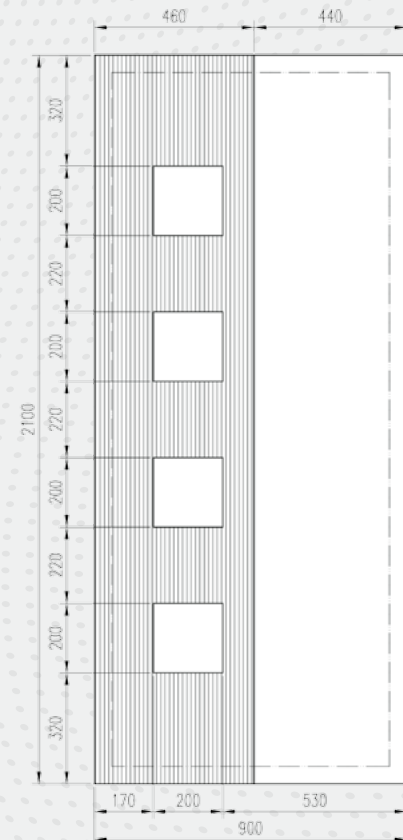

NINA



NINA
1 vidrio mate



NINA
1 vidrio fusing

- Aluminio
- Pvc
- Lacado Ral
- Anodizado
- Lacado Madera
- Foliado

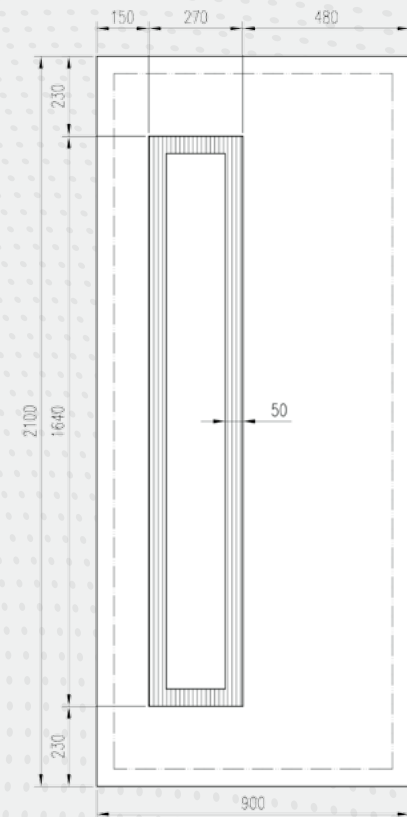

OLGA



OLGA
1 vidrio mate



OLGA
6 vidrios mate



OLGA
6 vidrios fusing



OLGA
1 vidrio fusing

- Aluminio
- Pvc
- Lacado Ral
- Anodizado
- Lacado Madera
- Foliado

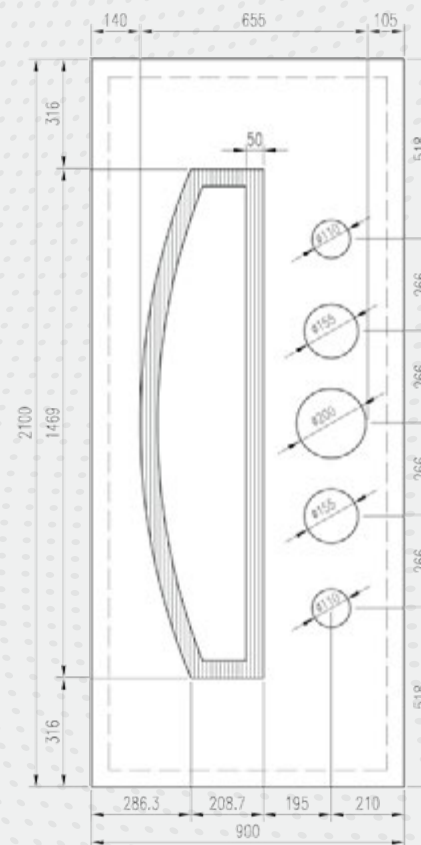

ROCÍO



ROCÍO
2 vidrios mate



ROCÍO
2 vidrios fusing

- Aluminio
- Pvc
- Lacado Ral
- Anodizado
- Lacado Madera
- Foliado

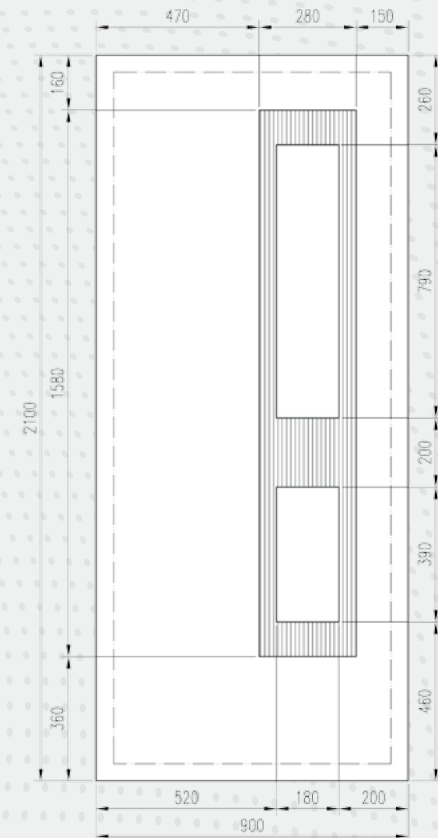

ROSA



ROSA
3 vidrios mate



ROSA
3 vidrios fusing

- Aluminio
- Pvc
- Lacado Ral
- Anodizado
- Lacado Madera
- Foliado

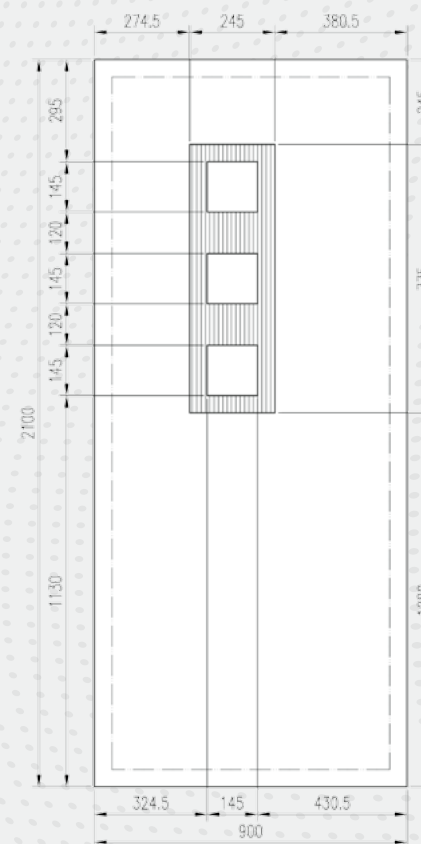

SARA



SARA
1 vidrio mate



SARA
1 vidrio fusing

- Aluminio
- Pvc
- Lacado Ral
- Anodizado
- Lacado Madera
- Foliado

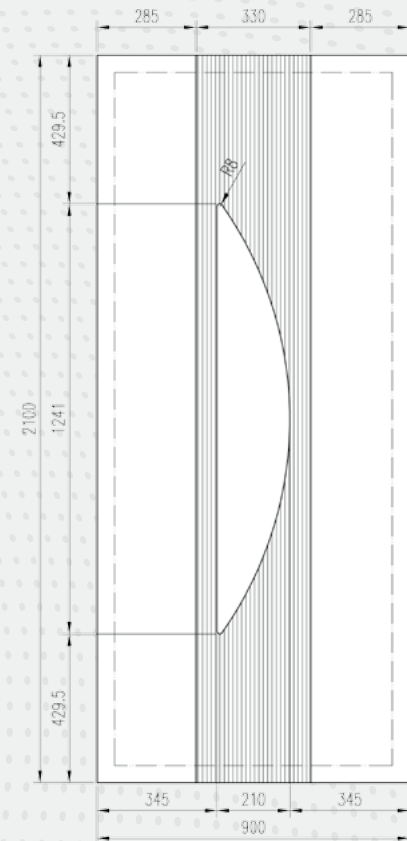

SOFÍA



SOFÍA
5 vidrios mate



SOFÍA
5 vidrios fusing

- Aluminio
- Pvc
- Lacado Ral
- Anodizado
- Lacado Madera
- Foliado

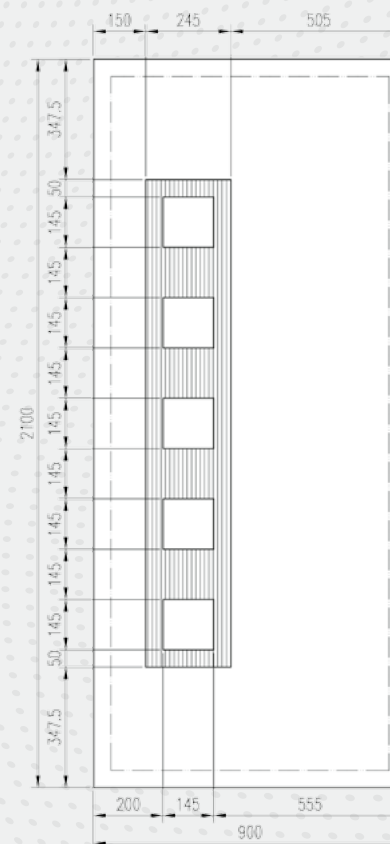

TANIA



TANIA
6 vidrios mate



TANIA
6 vidrios fusing

- Aluminio
- Pvc
- Lacado Ral
- Anodizado
- Lacado Madera
- Foliado

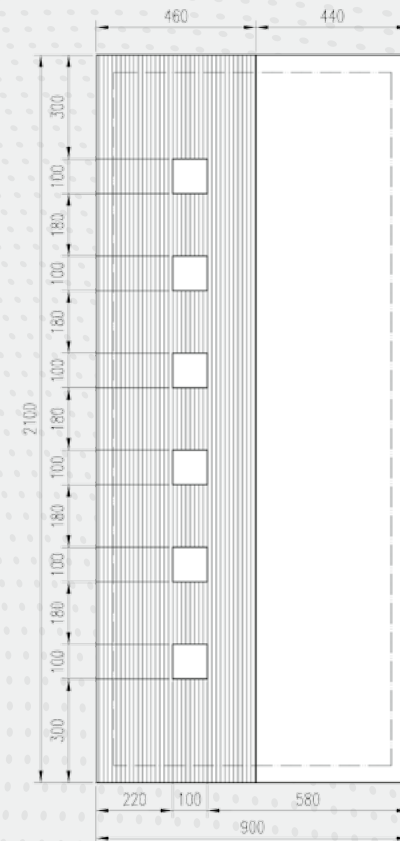



FANTASÍA

NÚCLEOS

XPS: $U = 1,57 \text{ W/m}^2 \text{ }^\circ\text{K}$

ALMA MIXTA: $U = 2,03 \text{ W/m}^2 \text{ }^\circ\text{K}$

TABLERO MARINO: $U = 2,77 \text{ W/m}^2 \text{ }^\circ\text{K}$

OPCIONES

Refuerzo Chapa Aluminio
Blindaje Chapa Acero

MEDIDAS FABRICACIÓN

2000 x 800

2100 x 900

2200 x 1000

2500 x 1250

ACABADOS

LACADOS RAL

ANODIZADO

LACADO MADERA

FOLIADO

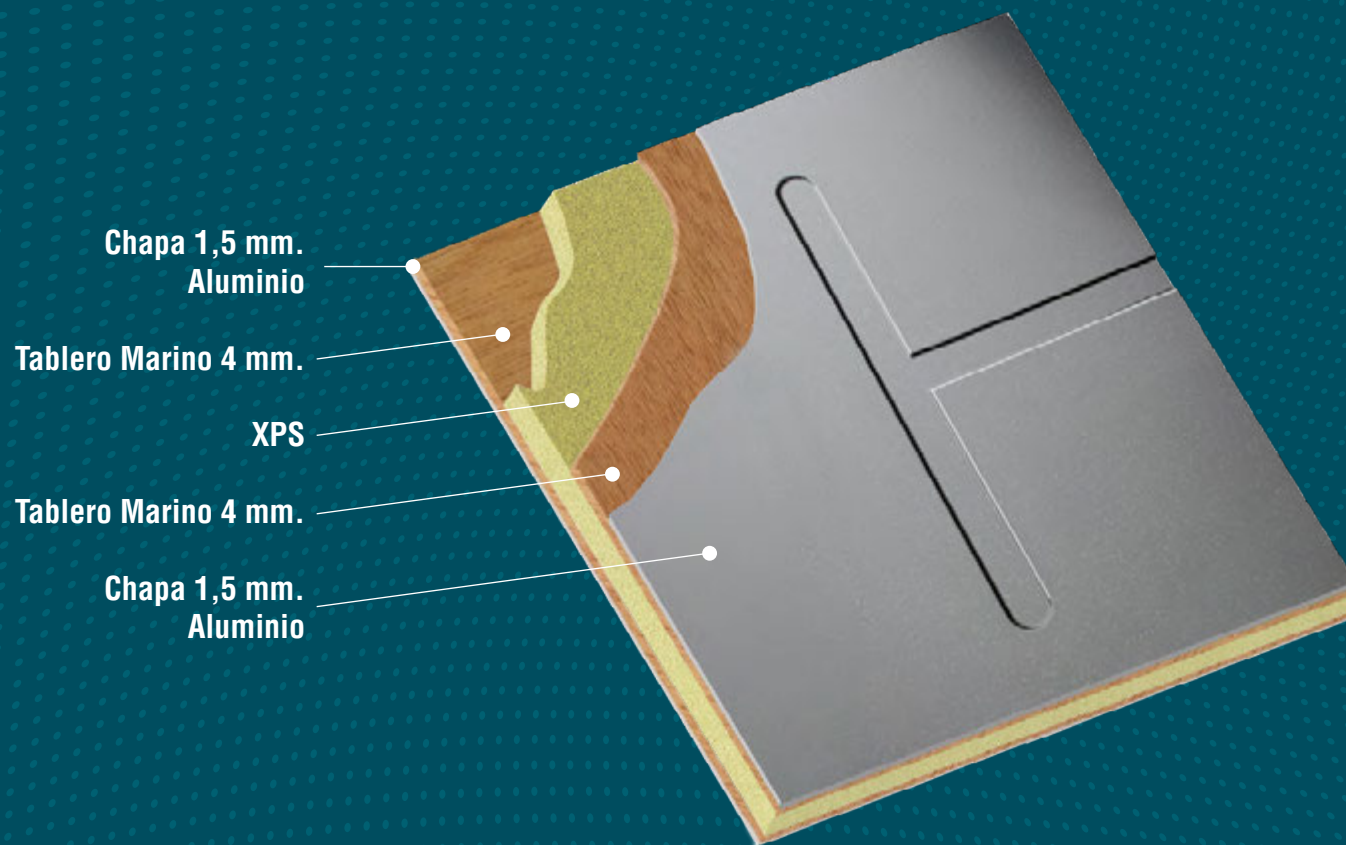

Vista de todos los modelos: Exterior.

ARGEL

BERLIN



- Aluminio
- Pvc
- Lacado Ral
- Anodizado
- Lacado Madera
- Foliado

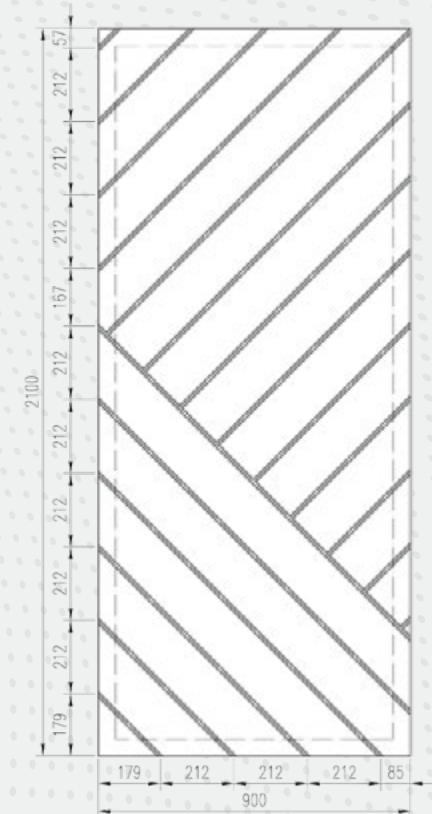
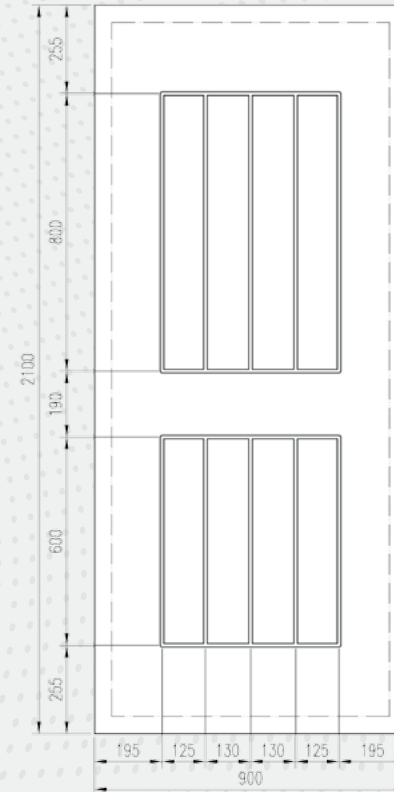

ARGEL

BERLIN

CAIRO



CAIRO



CAIRO
6 vidrios mate



CAIRO
6 vidrios fusing



CAIRO "M"
6 vidrios mate

CAIRO

- Aluminio
- Pvc
- Lacado Ral
- Anodizado
- Lacado Madera
- Foliado

CAIRO "M"

- Aluminio
- Pvc
- Lacado Ral
- Anodizado
- Lacado Madera
- Foliado

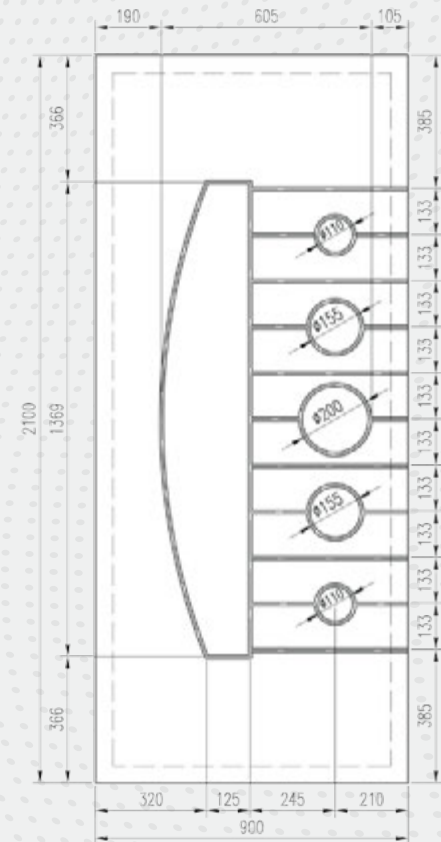

DAKAR



DAKAR



DAKAR
3 vidrios mate

- Aluminio
 - Pvc*
 - Lacado Ral
 - Anodizado
 - Lacado Madera
 - Foliado*
- * Solo acristalado

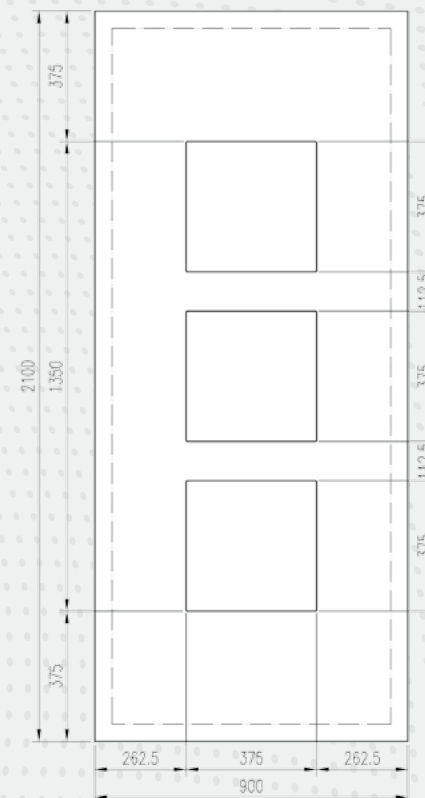

DUBLÍN



DUBLÍN



DUBLÍN
3 vidrios mate

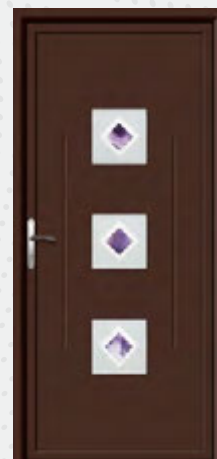

DUBLÍN
3 vidrios fusing



DUBLÍN "M"
3 vidrios mate

DUBLÍN

- Aluminio
- Pvc
- Lacado Ral
- Anodizado
- Lacado Madera
- Foliado

DUBLÍN "M"

- Aluminio
- Pvc
- Lacado Ral
- Anodizado
- Lacado Madera
- Foliado

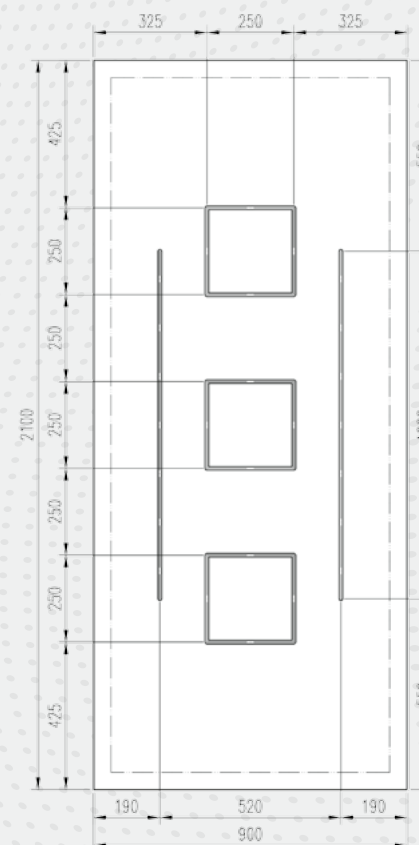

ESTOCOLMO



ESTOCOLMO



ESTOCOLMO
6 vidrios mate

- Aluminio
 - Pvc*
 - Lacado Ral
 - Anodizado
 - Lacado Madera
 - Foliado*
- * Solo acristalado
- * Solo acristalado

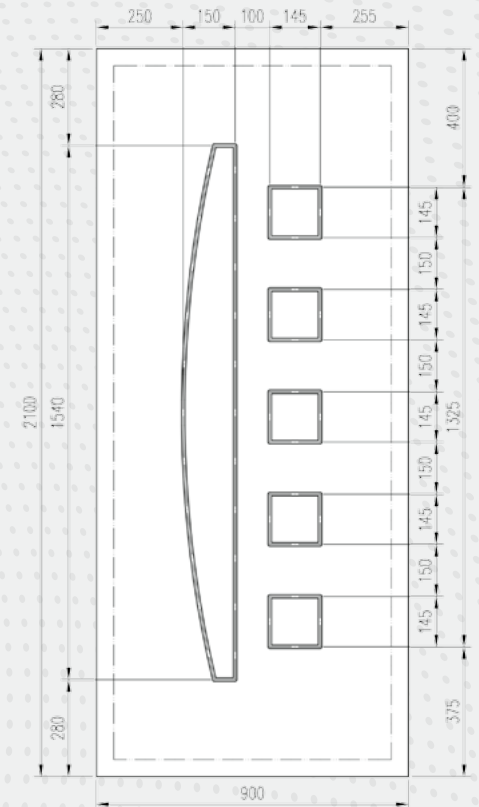

GUATEMALA



GUATEMALA



GUATEMALA
4 vidrios mate

- Aluminio
 - Pvc*
 - Lacado Ral
 - Anodizado
 - Lacado Madera
 - Foliado*
- * Solo acristalado

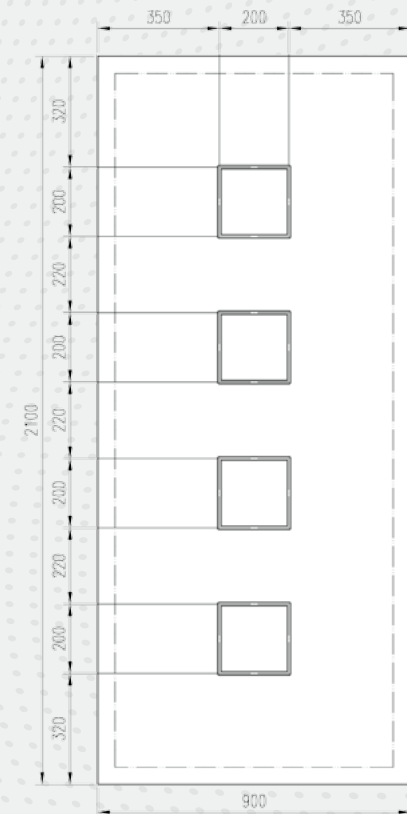

HELSINKI



HELSINKI



HELSINKI
5 vidrios mate

- Aluminio
 - Pvc*
 - Lacado Ral
 - Anodizado
 - Lacado Madera
 - Foliado*
- * Solo acristalado
- * Solo acristalado

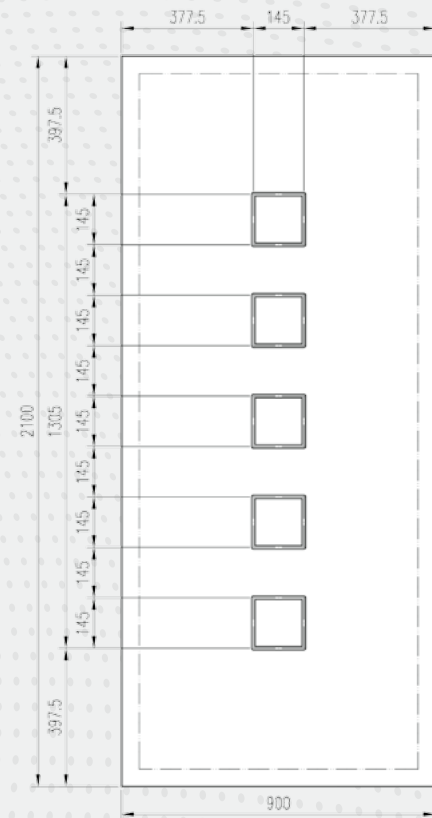

KAMPALA



KAMPALA



KAMPALA
7 vidrios mate

- Aluminio
 - Pvc*
 - Lacado Ral
 - Anodizado
 - Lacado Madera
 - Foliado*
- * Solo acristalado
- * Solo acristalado

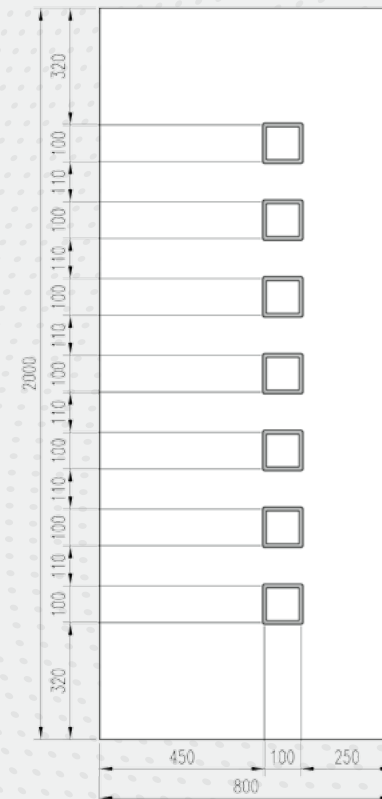

KIEV



KIEV



KIEV
5 vidrios mate

- Aluminio
 - Pvc*
 - Lacado Ral
 - Anodizado
 - Lacado Madera
 - Foliado*
- * Solo acristalado
- * Solo acristalado

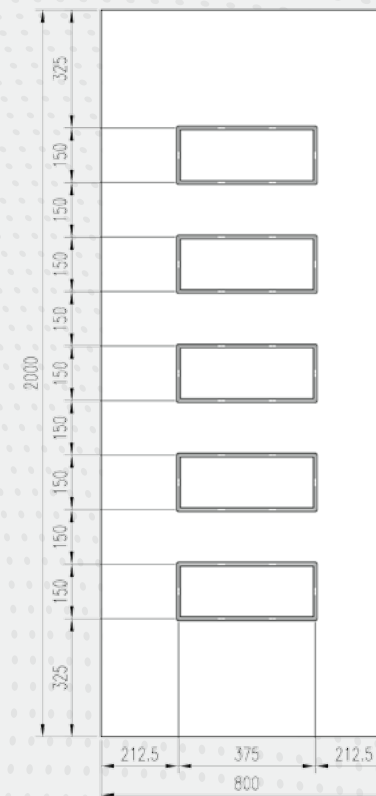

LIMA



LIMA



LIMA
3 vidrios mate



LIMA
3 vidrios fusing

- Aluminio
- Pvc
- Lacado Ral
- Anodizado
- Lacado Madera
- Foliado*

* Solo acristalado

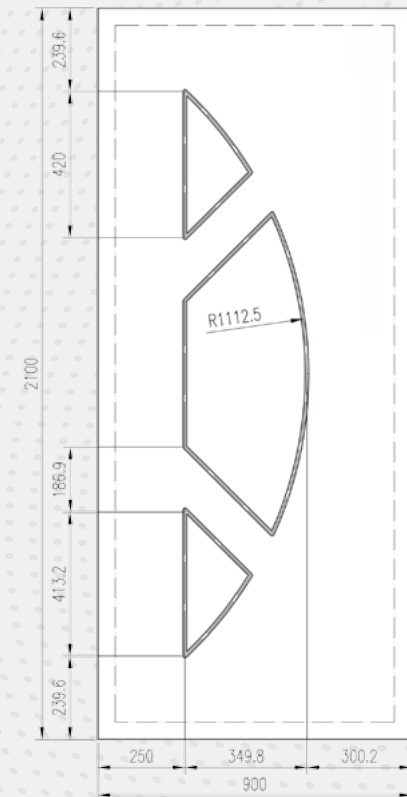

LISBOA



LISBOA



LISBOA
3 vidrios mate

- Aluminio
 - Pvc*
 - Lacado Ral
 - Anodizado
 - Lacado Madera
 - Foliado*
- * Solo acristalado

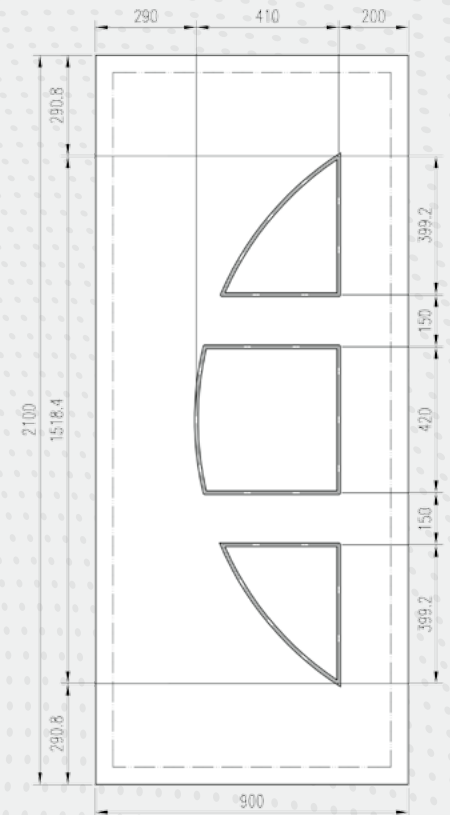

MADRID



MADRID



MADRID
4 vidrios mate



MADRID
4 vidrios fusing



MADRID "M"
4 vidrios mate

MADRID

- Aluminio
- Pvc
- Lacado Ral
- Anodizado
- Lacado Madera
- Foliado

MADRID "M"

- Aluminio
- Pvc
- Lacado Ral
- Anodizado
- Lacado Madera
- Foliado

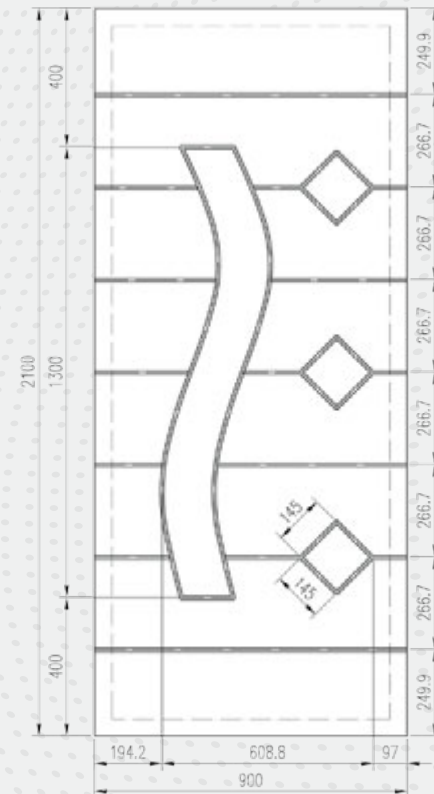

MOSCÚ



MOSCÚ



MOSCÚ
3 vidrios mate



MOSCÚ
3 vidrios fusing



MOSCÚ "M"
3 vidrios mate

MOSCÚ

- Aluminio
- Pvc
- Lacado Ral
- Anodizado
- Lacado Madera
- Foliado

MOSCÚ "M"

- Aluminio
- Pvc
- Lacado Ral
- Anodizado
- Lacado Madera
- Foliado

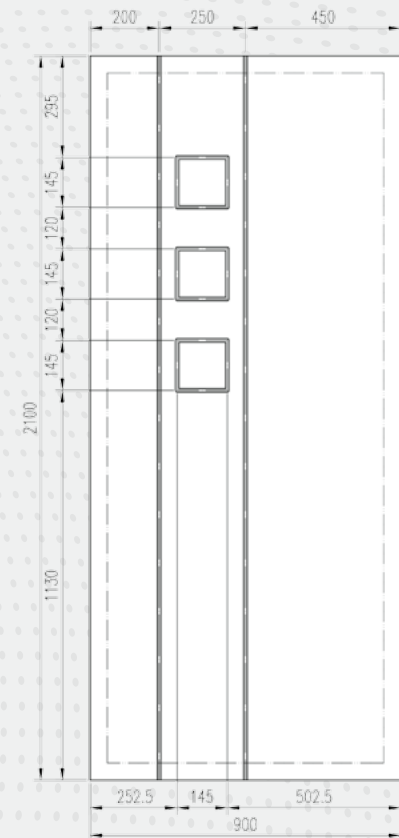

OSLO



OSLO



OSLO
3 vidrios mate



OSLO
3 vidrios fusing



OSLO "M"
3 vidrios mate

OSLO

- Aluminio
- Pvc
- Lacado Ral
- Anodizado
- Lacado Madera
- Foliado

OSLO "M"

- Aluminio
- Pvc
- Lacado Ral
- Anodizado
- Lacado Madera
- Foliado

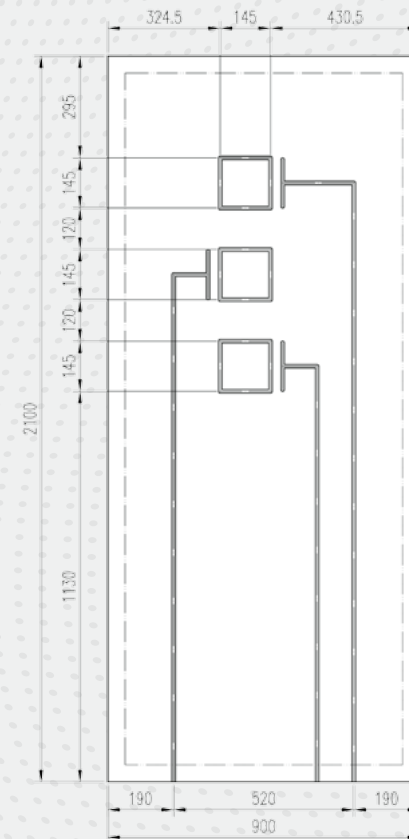

PARÍS



PARÍS

- Aluminio
- Pvc
- Lacado Ral
- Anodizado
- Lacado Madera
- Foliado

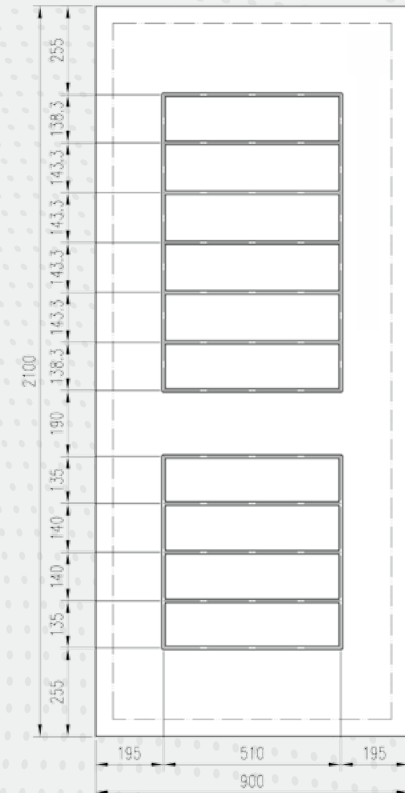

PEKÍN



PEKÍN



PEKÍN
2 vidrios mate



PEKÍN
2 vidrios fusing



PEKÍN "M"
2 vidrios mate

PEKÍN

- Aluminio
- Pvc
- Lacado Ral
- Anodizado
- Lacado Madera
- Foliado

PEKÍN "M"

- Aluminio
- Pvc
- Lacado Ral
- Anodizado
- Lacado Madera
- Foliado

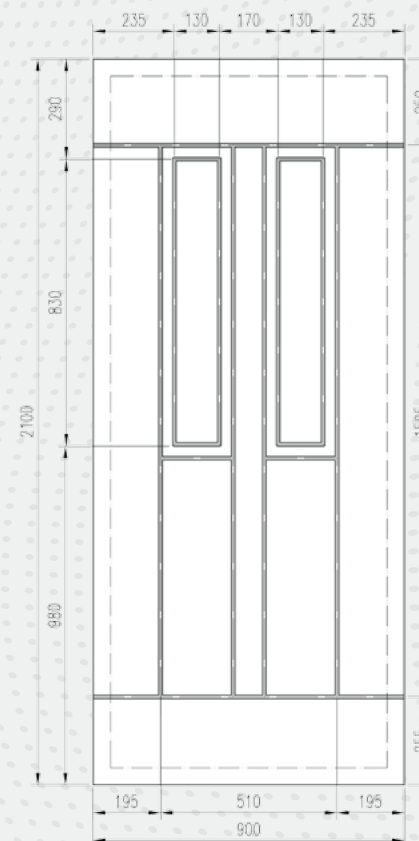

PRAGA



PRAGA



PRAGA
2 vidrios mate



PRAGA
2 vidrios fusing



PRAGA "M"
2 vidrios mate

PRAGA

- Aluminio
- Pvc

- Lacado Ral
- Anodizado
- Lacado Madera
- Foliado

PRAGA "M"

- Aluminio
- Pvc

- Lacado Ral
- Anodizado
- Lacado Madera
- Foliado

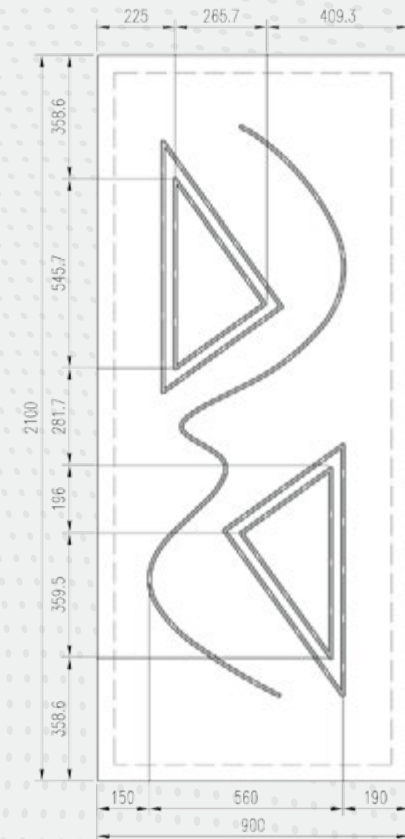

QUILLA



QUILLA

- Aluminio
- Pvc
- Lacado Ral
- Anodizado
- Lacado Madera
- Foliado

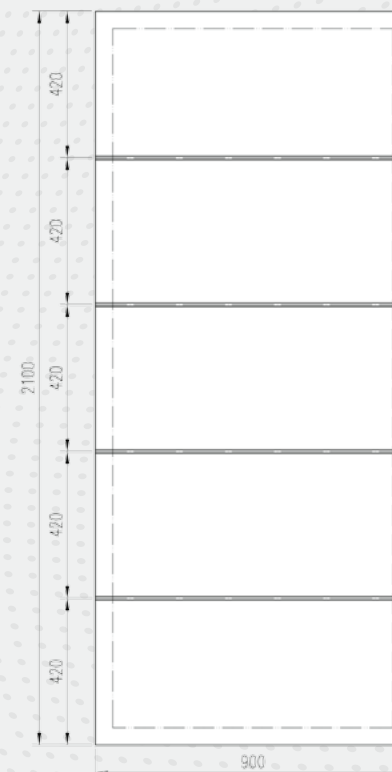

QUITO



QUITO



QUITO
1 vidrio mate



QUITO
1 vidrio fusing



QUITO "M"
1 vidrio mate

QUITO

- Aluminio
- Pvc
- Lacado Ral
- Anodizado
- Lacado Madera
- Foliado

QUITO "M"

- Aluminio
- Pvc
- Lacado Ral
- Anodizado
- Lacado Madera
- Foliado

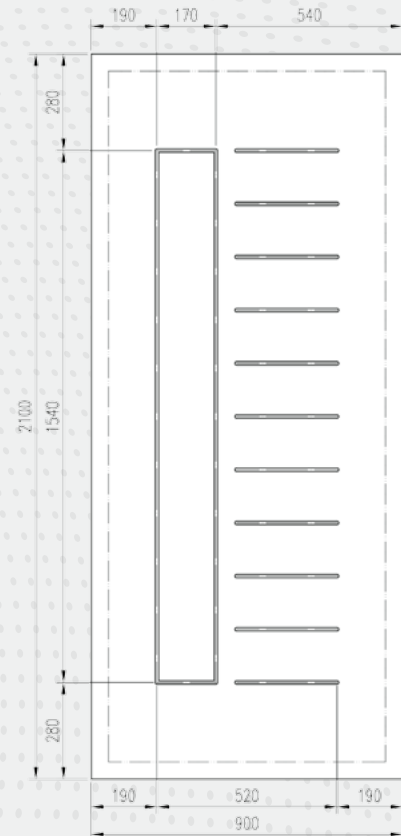

ROMA



ROMA



ROMA
2 vidrios mate



ROMA
2 vidrios fusing



ROMA "M"
2 vidrios mate

ROMA

- Aluminio
- Pvc
- Lacado Ral
- Anodizado
- Lacado Madera
- Foliado

ROMA "M"

- Aluminio
- Pvc
- Lacado Ral
- Anodizado
- Lacado Madera
- Foliado

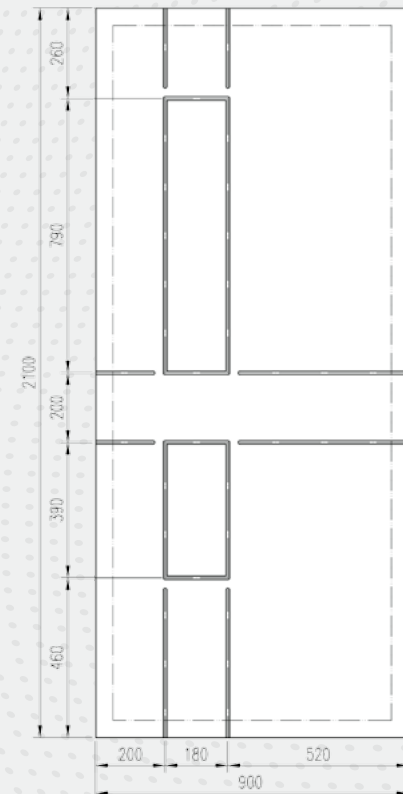

TAURO



TAURO
1 vidrio mate



TAURO "M"
1 vidrio mate

TAURO

- Aluminio
- Pvc
- Lacado Ral
- Anodizado
- Lacado Madera
- Foliado

TAURO "M"

- Aluminio
- Pvc
- Lacado Ral
- Anodizado
- Lacado Madera
- Foliado

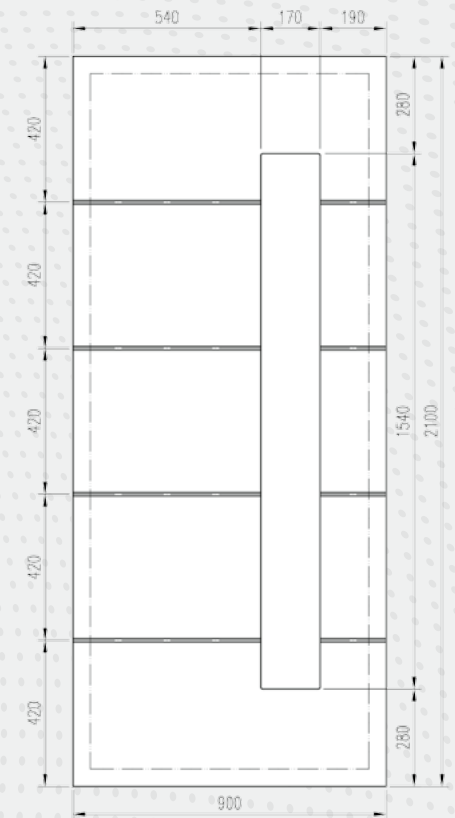

TOKIO



TOKIO



TOKIO
1 vidrio mate



TOKIO
1 vidrio fusing



TOKIO "M"
1 vidrio mate

TOKIO

- Aluminio
- Pvc
- Lacado Ral
- Anodizado
- Lacado Madera
- Foliado

TOKIO "M"

- Aluminio
- Pvc
- Lacado Ral
- Anodizado
- Lacado Madera
- Foliado

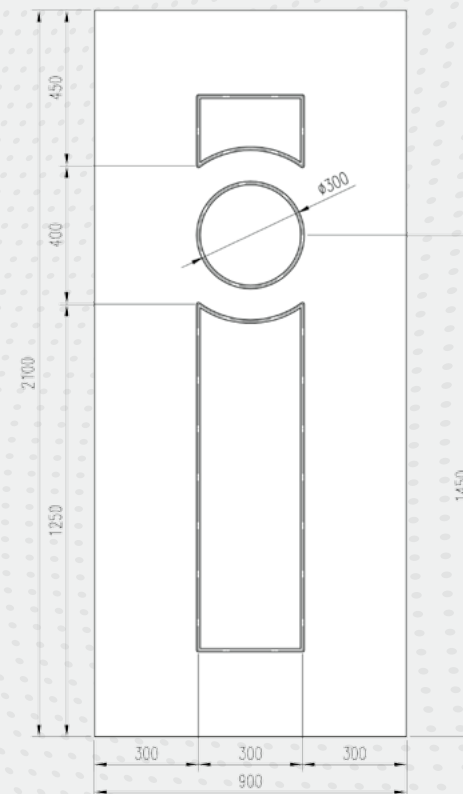

TÚNEZ



TÚNEZ



TÚNEZ
1 vidrio mate



TÚNEZ
1 vidrio fusing



TÚNEZ "M"
1 vidrio mate

TÚNEZ

- Aluminio
- Pvc
- Lacado Ral
- Anodizado
- Lacado Madera
- Foliado

TÚNEZ "M"

- Aluminio
- Pvc
- Lacado Ral
- Anodizado
- Lacado Madera
- Foliado

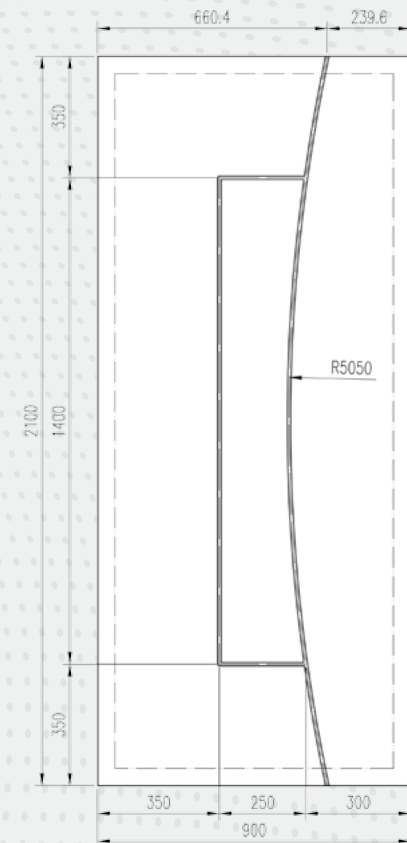

VIENA



VIENA



VIENA
5 vidrios mate



VIENA
5 vidrios fusing



VIENA "M"
5 vidrios mate

VIENA

- Aluminio
- Pvc
- Lacado Ral
- Anodizado
- Lacado Madera
- Foliado

VIENA "M"

- Aluminio
- Pvc
- Lacado Ral
- Anodizado
- Lacado Madera
- Foliado

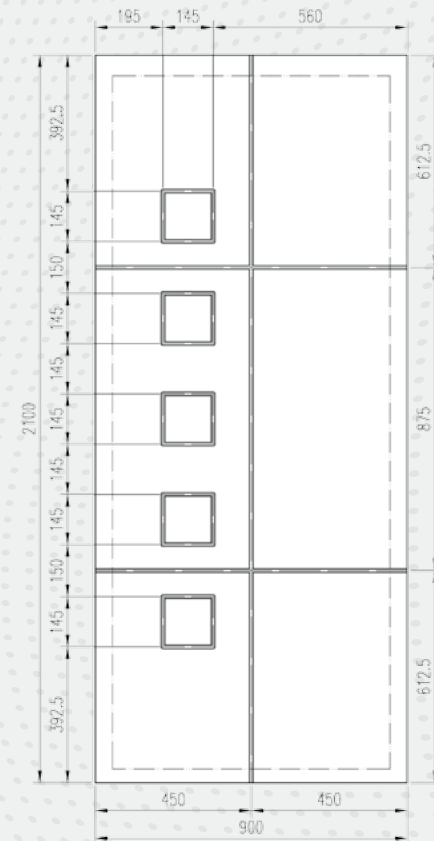

YAKARTA



YAKARTA

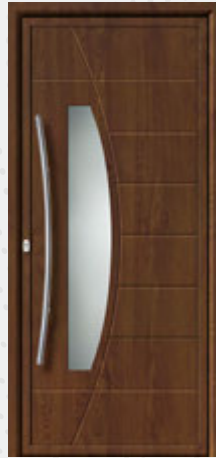

YAKARTA
1 vidrio mate



YAKARTA "M"
1 vidrio mate

YAKARTA

- Aluminio
- Pvc

- Lacado Ral
- Anodizado
- Lacado Madera
- Foliado

YAKARTA "M"

- Aluminio
- Pvc

- Lacado Ral
- Anodizado
- Lacado Madera
- Foliado

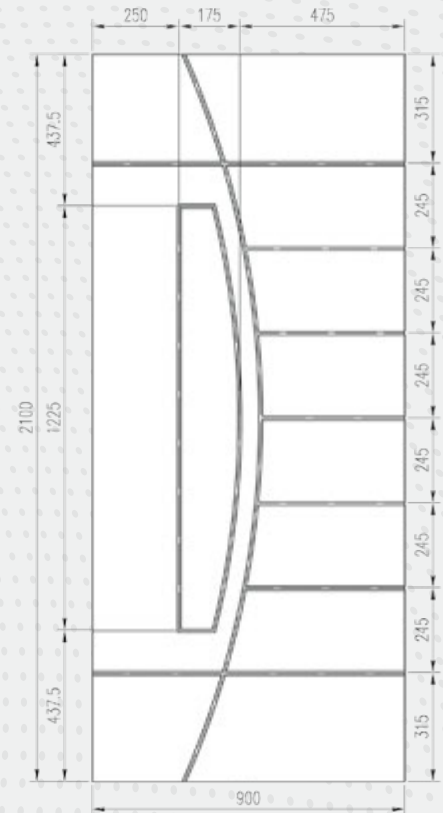

FUTURA

NÚCLEOS

XPS: $U = 1,57 \text{ W/m}^2 \text{ }^\circ\text{K}$

ALMA MIXTA: $U = 2,03 \text{ W/m}^2 \text{ }^\circ\text{K}$

TABLERO MARINO: $U = 2,77 \text{ W/m}^2 \text{ }^\circ\text{K}$

OPCIONES

Refuerzo Chapa Aluminio
Blindaje Chapa Acero

MEDIDAS FABRICACIÓN

2000 x 800

2100 x 900

2200 x 1000

2500 x 1250

ACABADOS

LACADOS RAL

ANODIZADO

LACADO MADERA

FOLIADO

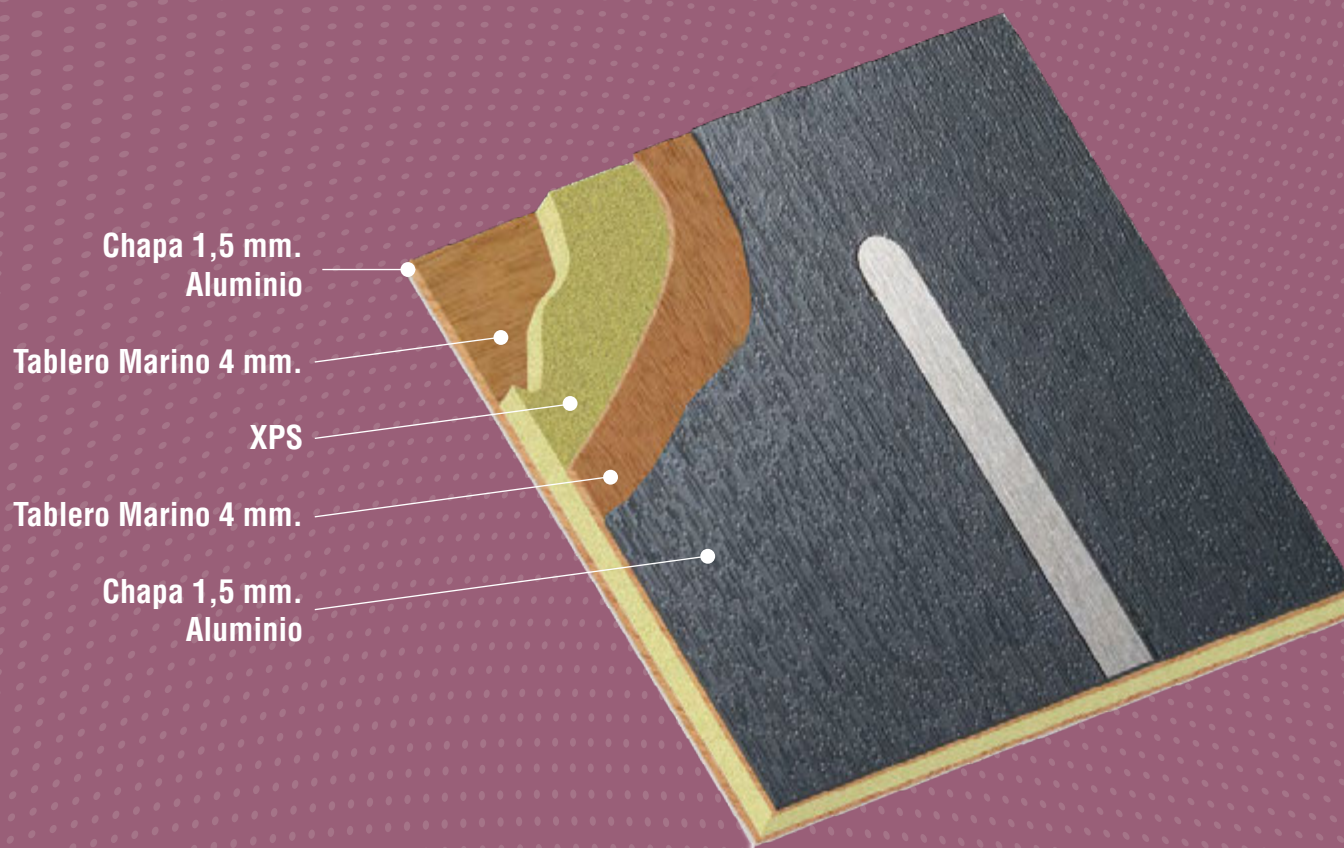

Vista de todos los modelos: Exterior.

Detalles de inserción del Alunox



POSTERIOR

Decoración de alunox adherida por el interior del panel, quedando bajo la chapa.

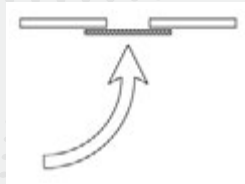

ENRASADO

Decoración de alunox insertada en el panel, quedando enrasada con el resto de la superficie.



SUPERIOR

Decoración de alunox adherida por encima del panel de puerta.

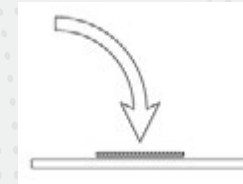

ALTAR



ALTAR
ciego Alunox



ALTAR "M"
ciego Alunox



ALTAR

- Aluminio
- Pvc
- Lacado Ral
- Anodizado
- Lacado Madera
- Foliado

ALTAR "M"

- Aluminio
- Pvc
- Lacado Ral
- Anodizado
- Lacado Madera
- Foliado

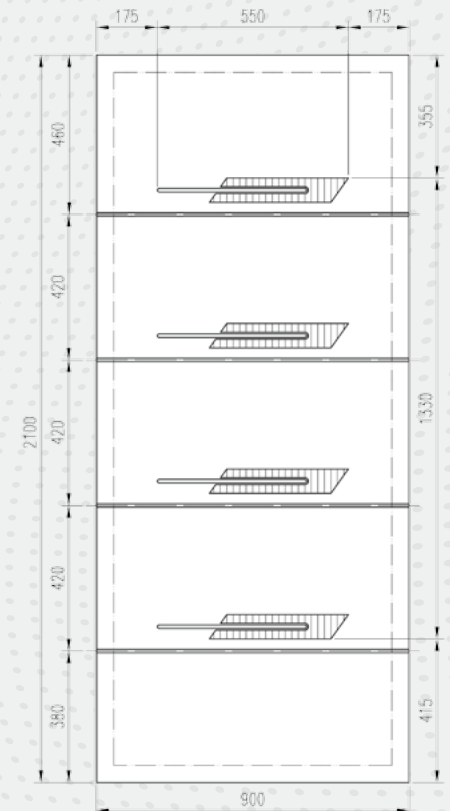

AUSTRAL



AUSTRAL



AUSTRAL
1 vidrio mate



- Aluminio
- Pvc
- Lacado Ral
- Anodizado
- Lacado Madera
- Foliado

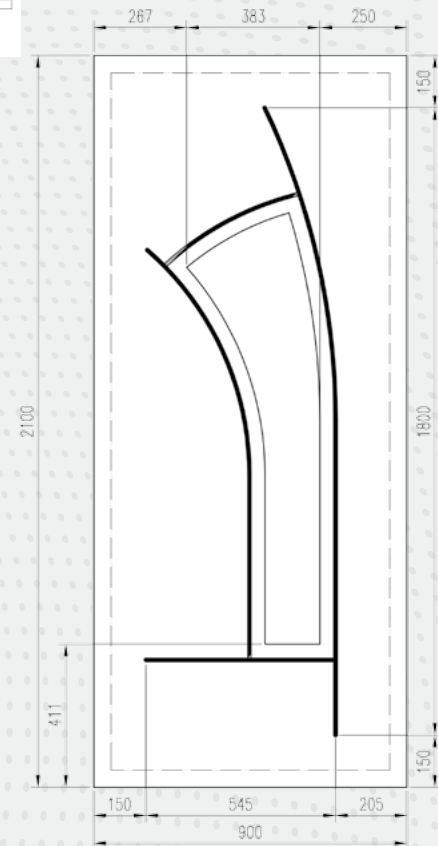

BOREAL



BOREAL



BOREAL
6 vidrios mate

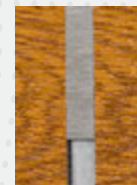

- Aluminio
- Pvc
- Lacado Ral
- Anodizado
- Lacado Madera
- Foliado

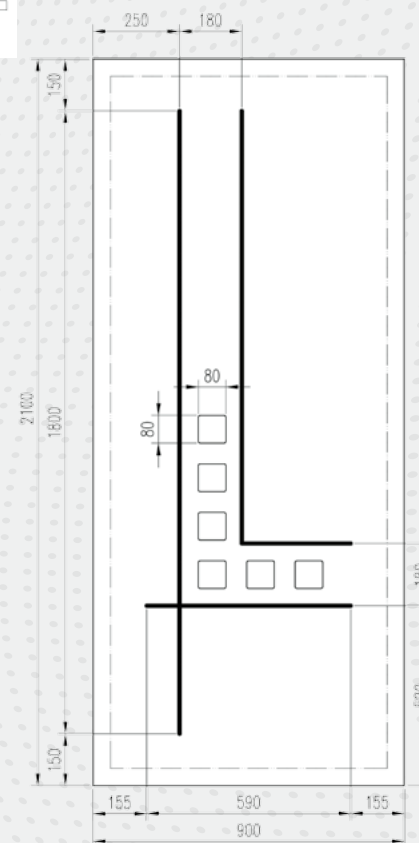

BURIL



BURIL
ciego Alunox



BURIL "M"
ciego Alunox



BURIL

- Aluminio
- Pvc
- Lacado Ral
- Anodizado
- Lacado Madera
- Foliado

BURIL "M"

- Aluminio
- Pvc
- Lacado Ral
- Anodizado
- Lacado Madera
- Foliado

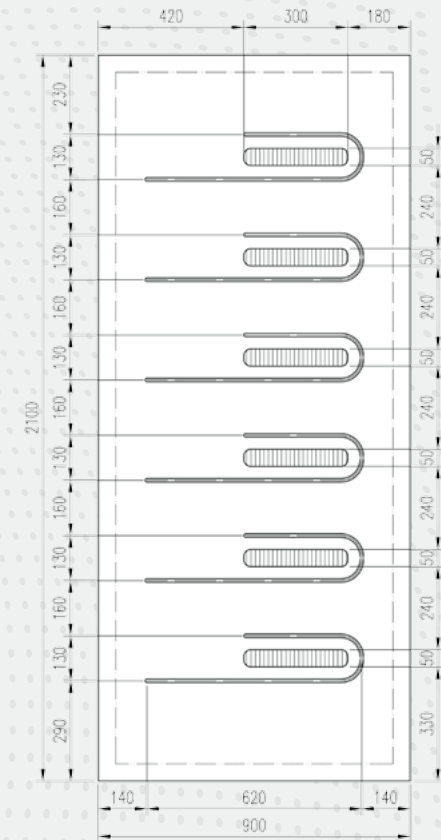

CAPRICORNIO



CAPRICORNIO

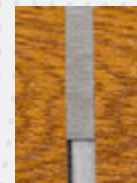

- Aluminio
- Pvc
- Lacado Ral
- Anodizado
- Lacado Madera
- Foliado

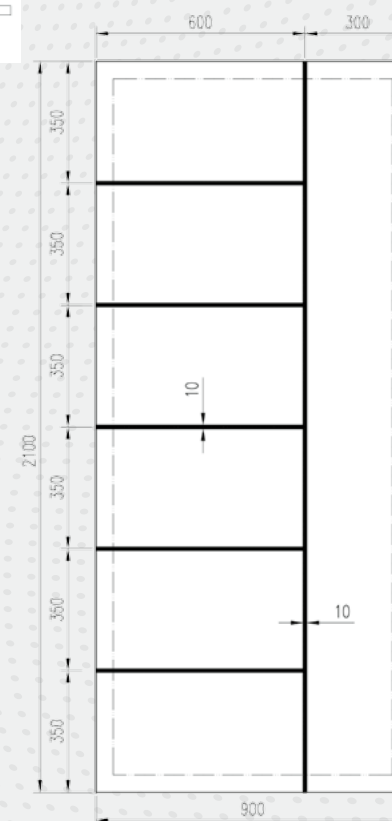

CASIOPEA



CASIOPEA

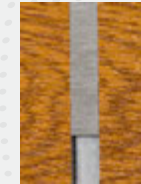

- Aluminio
- Pvc
- Lacado Ral
- Anodizado
- Lacado Madera
- Foliado

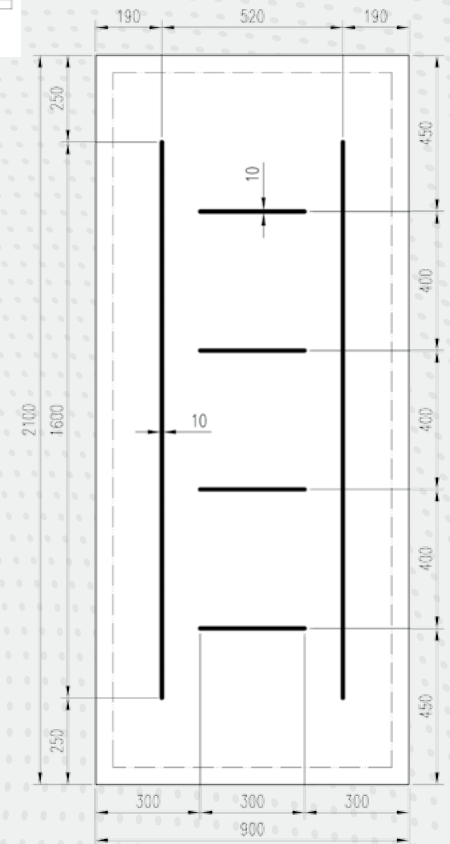

CEFEQ



CEFEQ

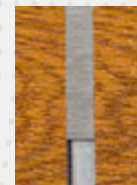

- Aluminio
- Pvc
- Lacado Ral
- Anodizado
- Lacado Madera
- Foliado

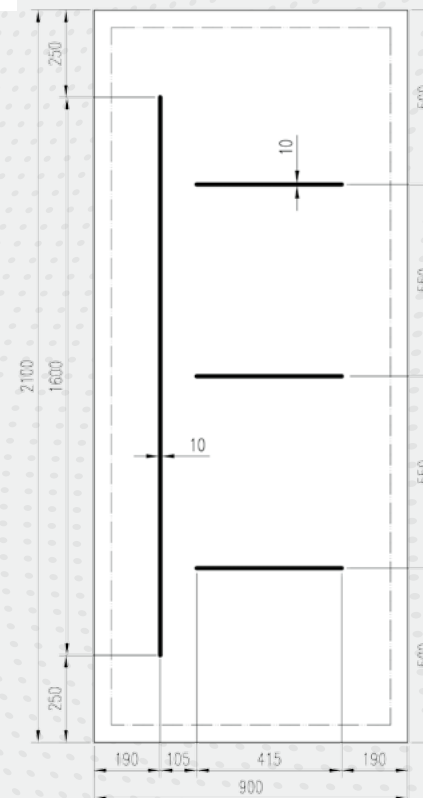

CENIT



CENIT



- Aluminio
- Pvc
- Lacado Ral
- Anodizado
- Lacado Madera
- Foliado

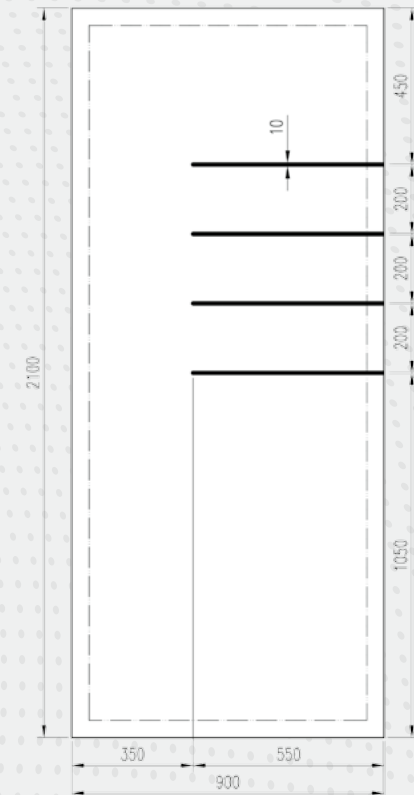

CENTAURO



CENTAURO



- Aluminio
- Pvc
- Lacado Ral
- Anodizado
- Lacado Madera
- Foliado

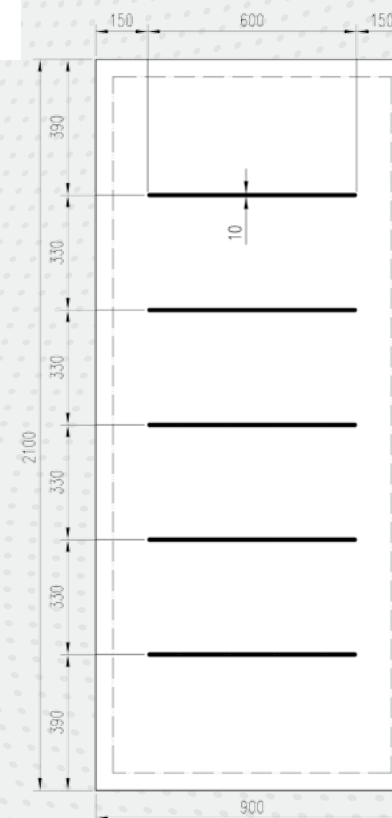

CINCEL



CINCEL 3R



- Aluminio
- Pvc
- Lacado Ral
- Anodizado
- Lacado Madera
- Foliado

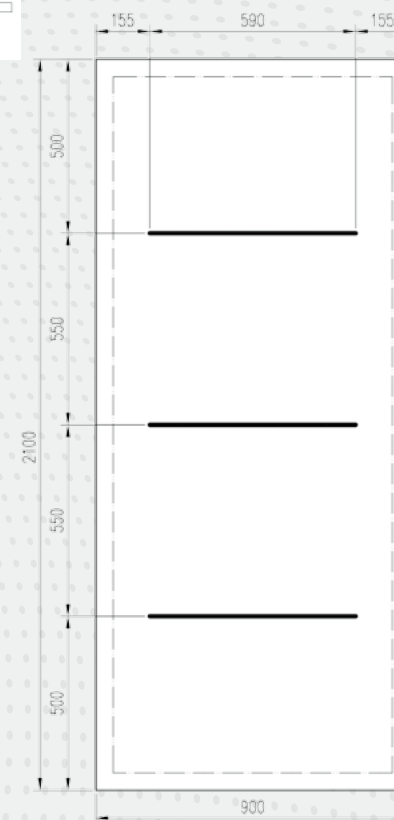

DELFIN



DELFIN
ciego Alunox



DELFIN "M"
ciego Alunox



DELFIN

- Aluminio
- Pvc
- Lacado Ral
- Anodizado
- Lacado Madera
- Foliado

DELFIN "M"

- Aluminio
- Pvc
- Lacado Ral
- Anodizado
- Lacado Madera
- Foliado

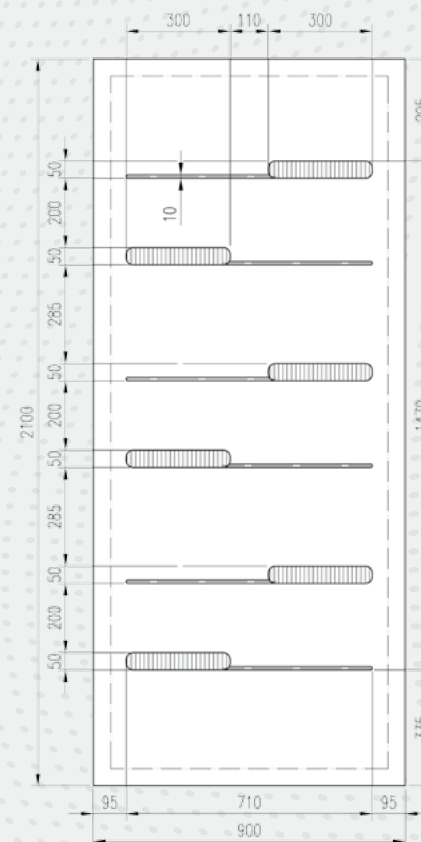

ERIDANO



ERIDANO



ERIDANO
4 vidrios mate



- Aluminio
- Pvc
- Lacado Ral
- Anodizado
- Lacado Madera
- Foliado

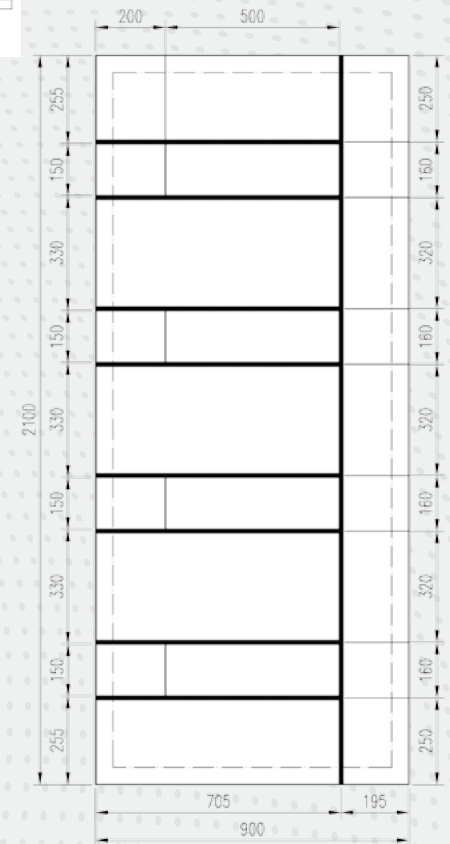

ESCORPIO



ESCORPIO



ESCORPIO
3 vidrios mate

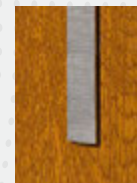

- Aluminio
- Pvc
- Lacado Ral
- Anodizado
- Lacado Madera
- Foliado

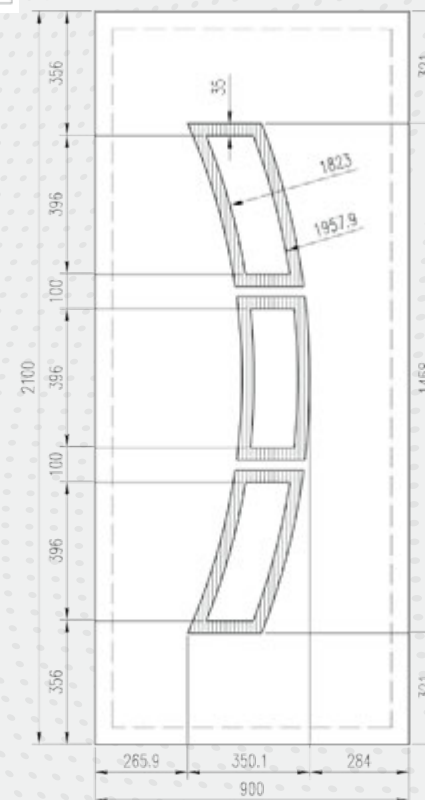

FÉNIX



FÉNIX
1 vidrio mate



FÉNIX "M"
1 vidrio mate



FÉNIX

- Aluminio
- Pvc
- Lacado Ral
- Anodizado
- Lacado Madera
- Foliado

FÉNIX "M"

- Aluminio
- Pvc
- Lacado Ral
- Anodizado
- Lacado Madera
- Foliado

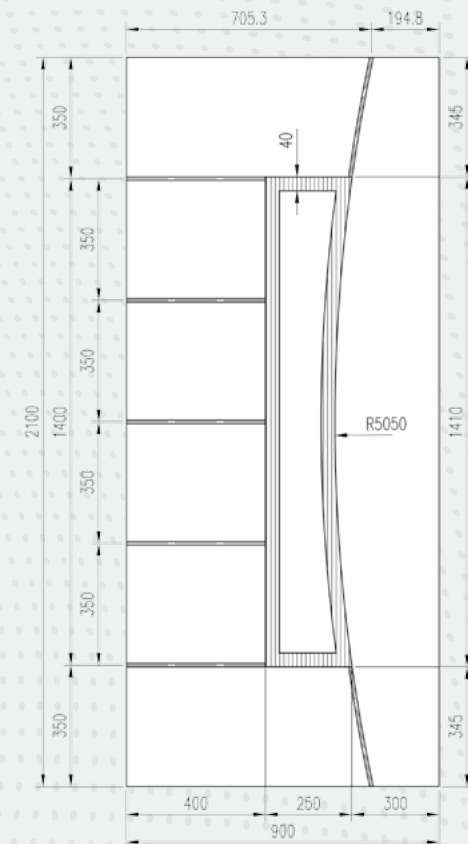

GAMMA



GAMMA



GAMMA
3 vidrios mate



- Aluminio
- Pvc
- Lacado Ral
- Anodizado
- Lacado Madera
- Foliado

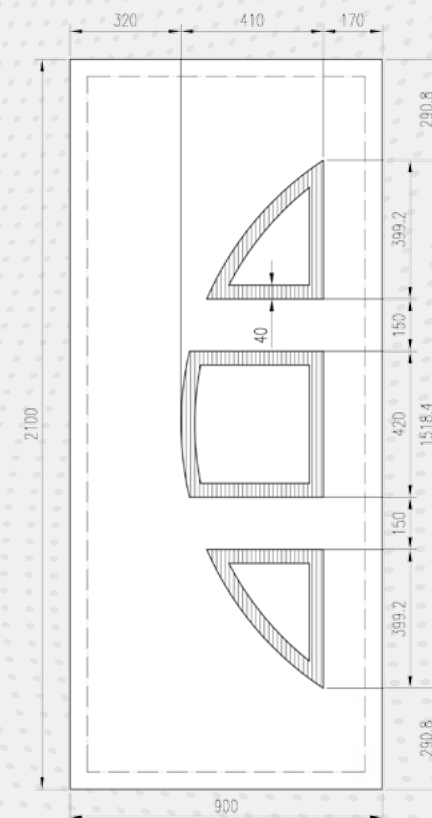

GRULLA



GRULLA
ciego Alunox



GRULLA "M"
ciego Alunox



GRULLA

- Aluminio
- Pvc
- Lacado Ral
- Anodizado
- Lacado Madera
- Foliado

GRULLA "M"

- Aluminio
- Pvc
- Lacado Ral
- Anodizado
- Lacado Madera
- Foliado

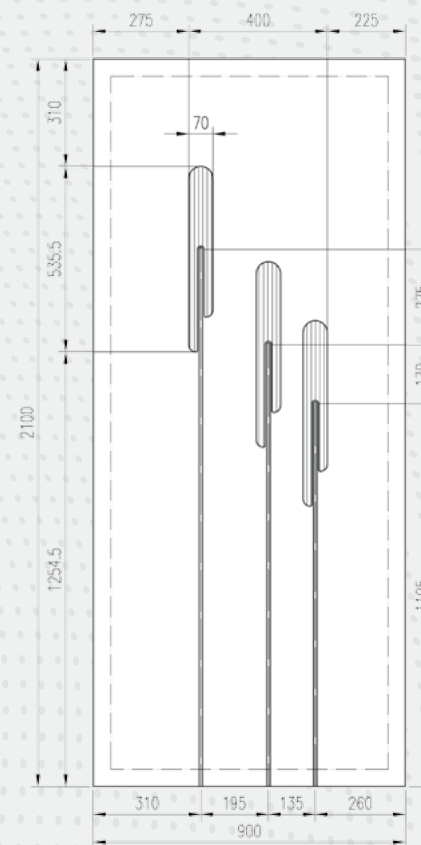

HADAR



HADAR



HADAR
3 vidrios mate



- Aluminio
- Pvc
- Lacado Ral
- Anodizado
- Lacado Madera
- Foliado

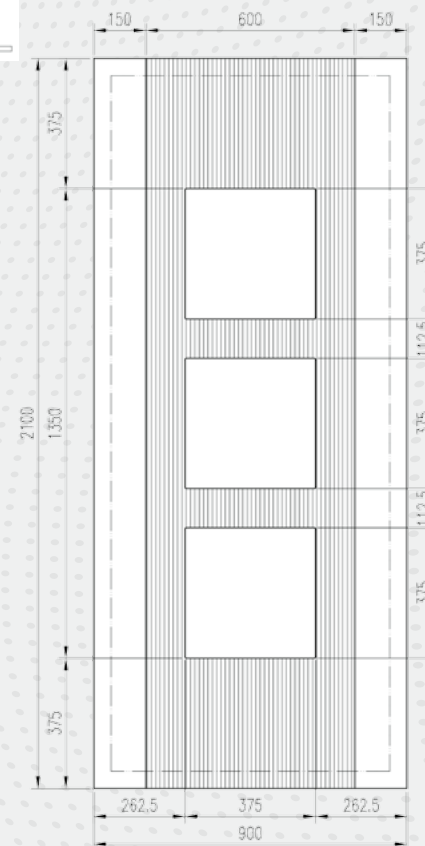

HÉRCULES



HÉRCULES



HÉRCULES
5 vidrios mate



- Aluminio
- Pvc
- Lacado Ral
- Anodizado
- Lacado Madera
- Foliado

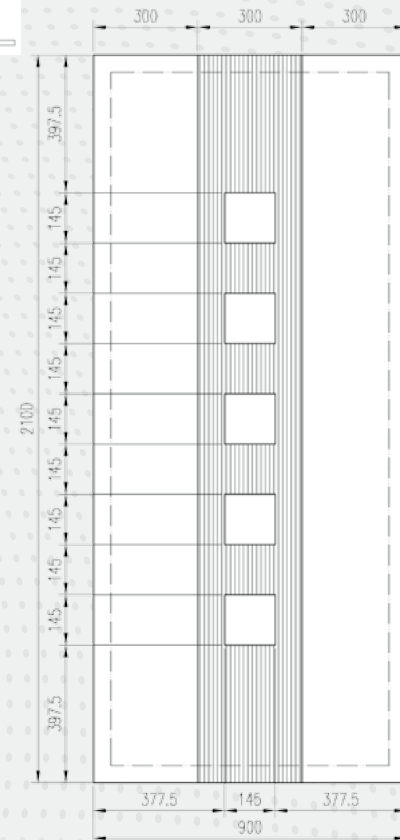

HIDRA



HIDRA
ciego Alunox



HIDRA "M"
ciego Alunox



HIDRA

- Aluminio
- Pvc
- Lacado Ral
- Anodizado
- Lacado Madera
- Foliado

HIDRA "M"

- Aluminio
- Pvc
- Lacado Ral
- Anodizado
- Lacado Madera
- Foliado

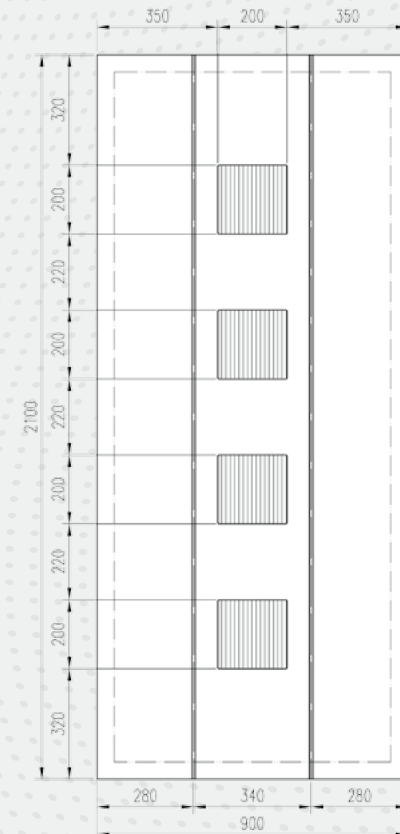

INCA



INCA



- Aluminio
- Pvc
- Lacado Ral
- Anodizado
- Lacado Madera
- Foliado

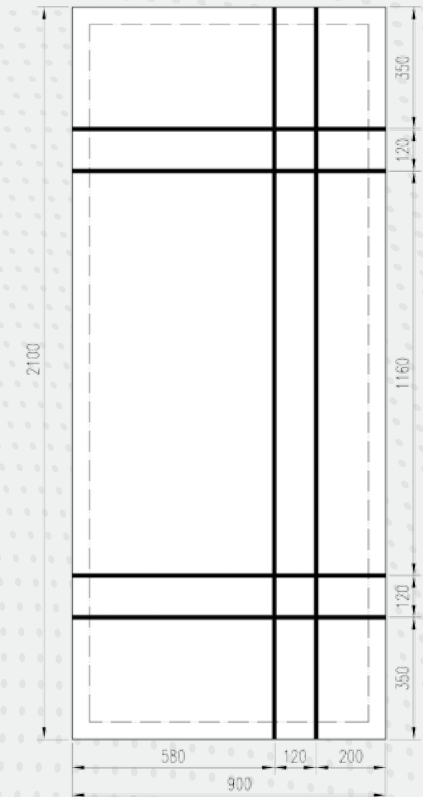

KIMA



KIMA



KIMA
2 vidrios mate

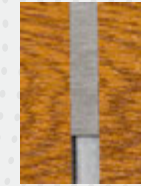

- Aluminio
- Pvc
- Lacado Ral
- Anodizado
- Lacado Madera
- Foliado

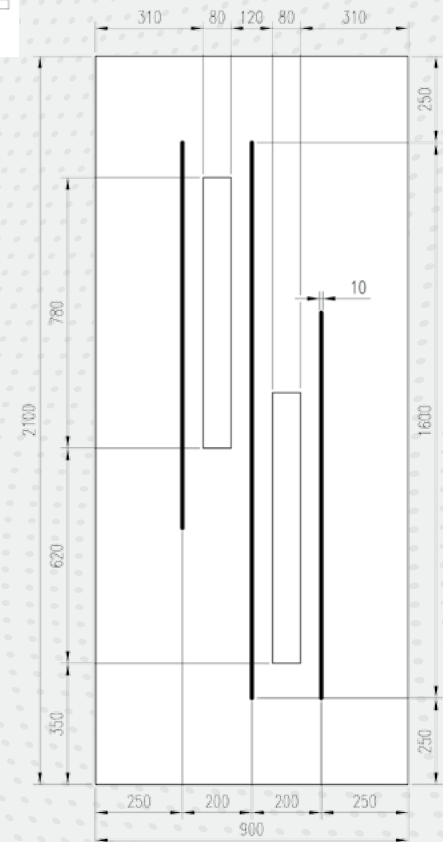

LIBRA



LIBRA
ciego Alunox

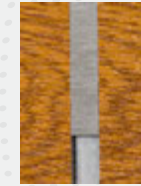

- Aluminio
- Pvc
- Lacado Ral
- Anodizado
- Lacado Madera
- Foliado

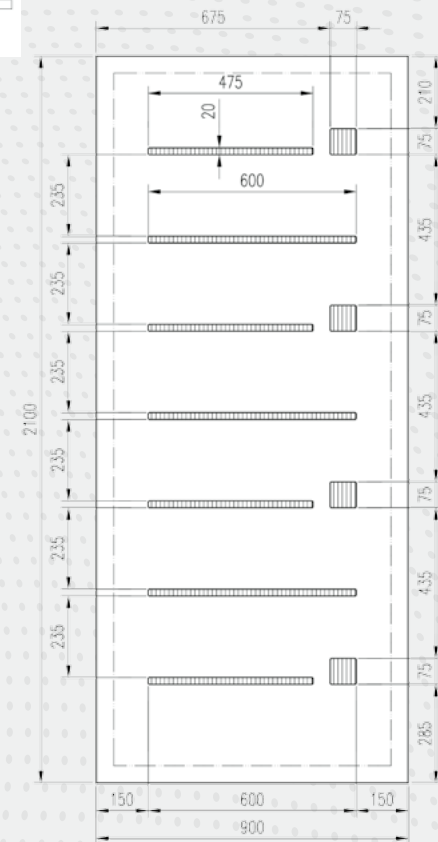

OCTANTE



OCTANTE
1 vidrio mate



- Aluminio
- Pvc
- Lacado Ral
- Anodizado
- Lacado Madera
- Foliado

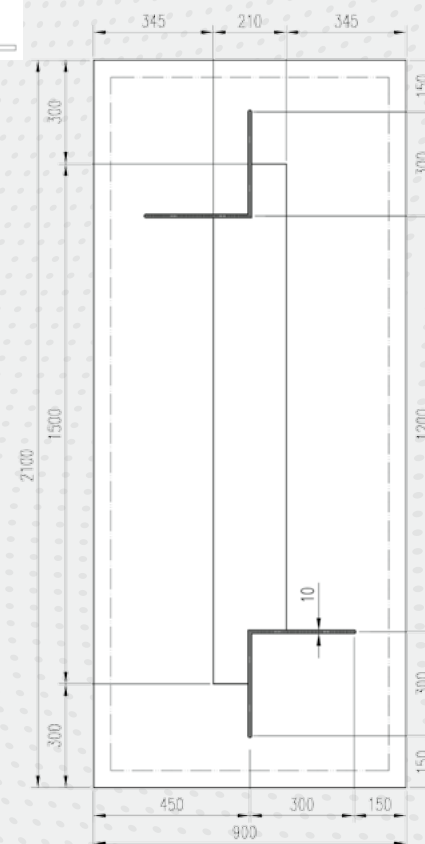

OLIMPO



OLIMPO
ciego Alunox



- Aluminio
- Pvc
- Lacado Ral
- Anodizado
- Lacado Madera
- Foliado

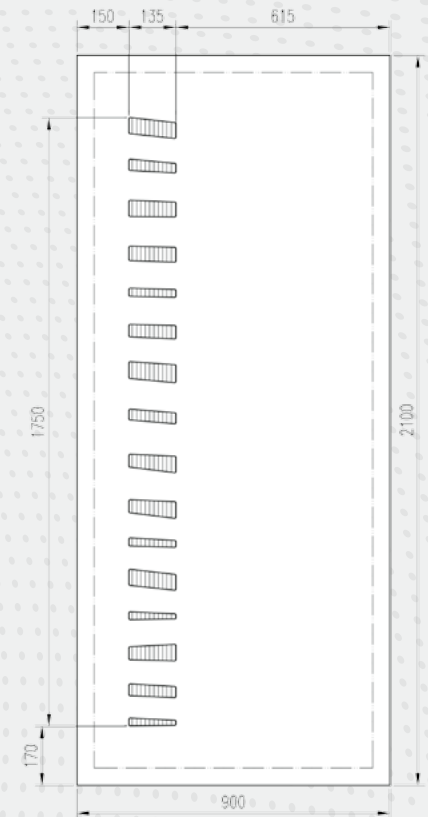

PEGASO



PEGASO
5 vidrios mate



- Aluminio
 - Pvc
-
- Lacado Ral
 - Anodizado
 - Lacado Madera
 - Foliado

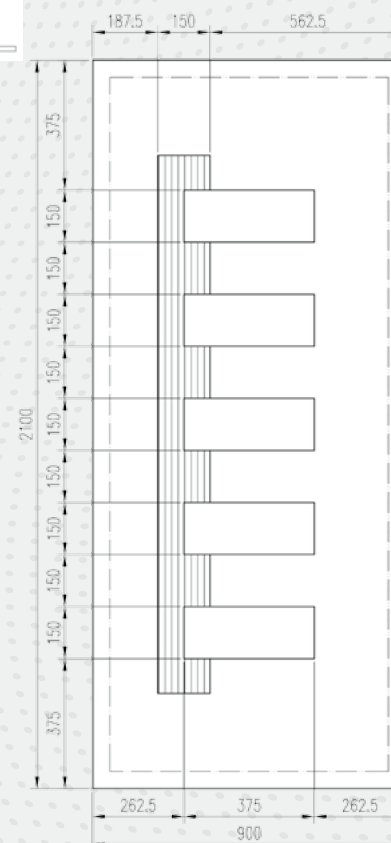

PERSEO

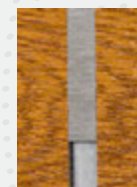

PERSEO

- Aluminio
- Pvc

- Lacado Ral
- Anodizado
- Lacado Madera
- Foliado

PERSEO "M"

- Aluminio
- Pvc

- Lacado Ral
- Anodizado
- Lacado Madera
- Foliado

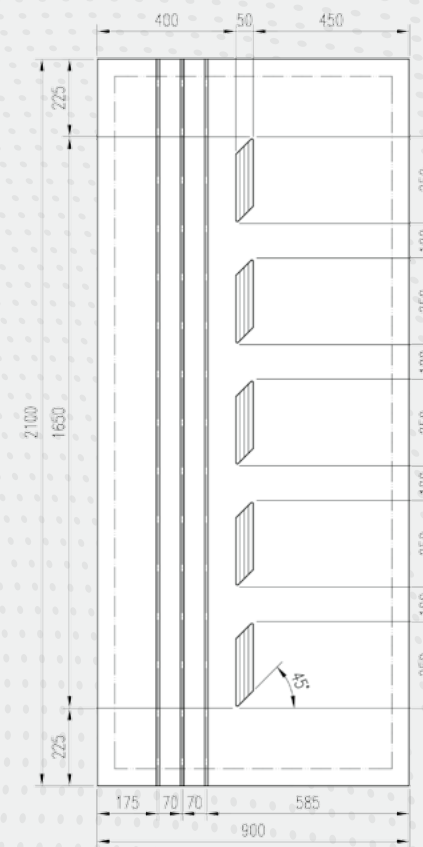

PERSEO "M"
ciego Alunox

REGULO



REGULO



REGULO
1 vidrio mate

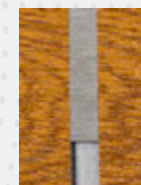

- Aluminio
- Pvc
- Lacado Ral
- Anodizado
- Lacado Madera
- Foliado

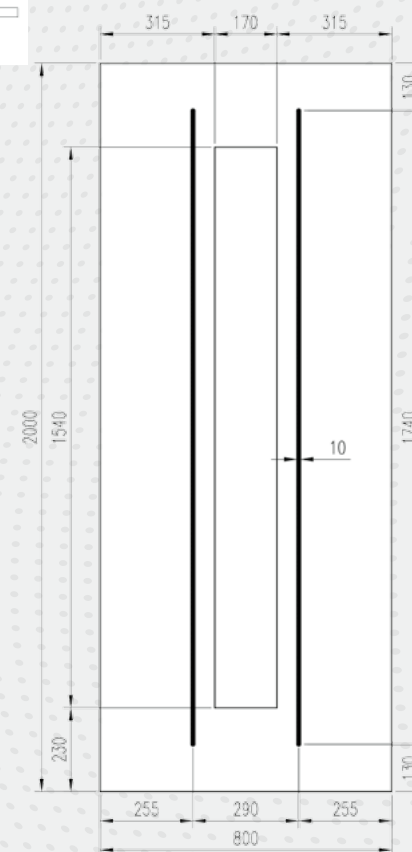

SAGITARIO



SAGITARIO
2R



SAGITARIO
2X2



- Aluminio
- Pvc
- Lacado Ral
- Anodizado
- Lacado Madera
- Foliado

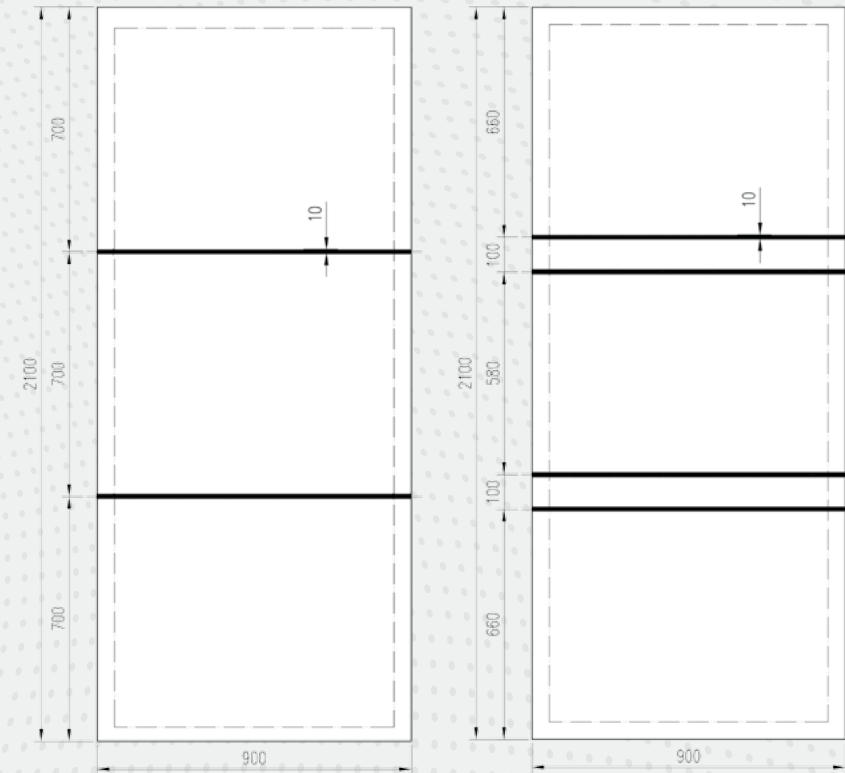

SAGITARIO



SAGITARIO
3R



SAGITARIO
3X2

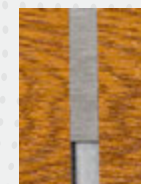

- Aluminio
- Pvc
- Lacado Ral
- Anodizado
- Lacado Madera
- Foliado

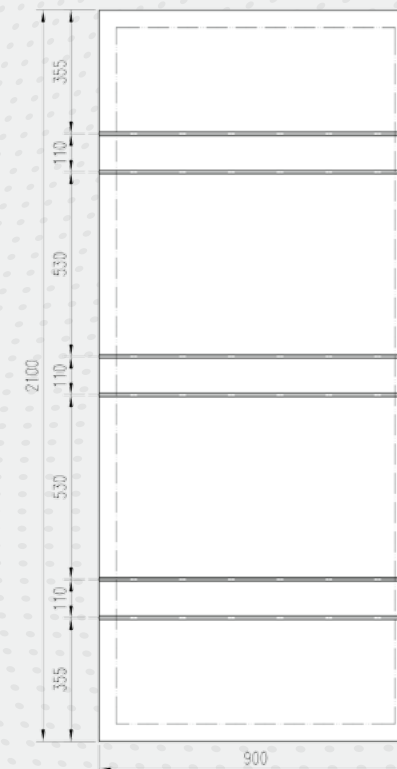
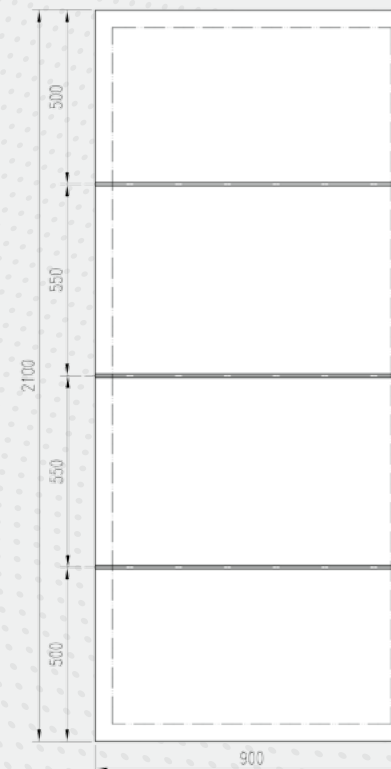

SAGITARIO



SAGITARIO
4R



SAGITARIO
6R



- Aluminio
- Pvc
- Lacado Ral
- Anodizado
- Lacado Madera
- Foliado

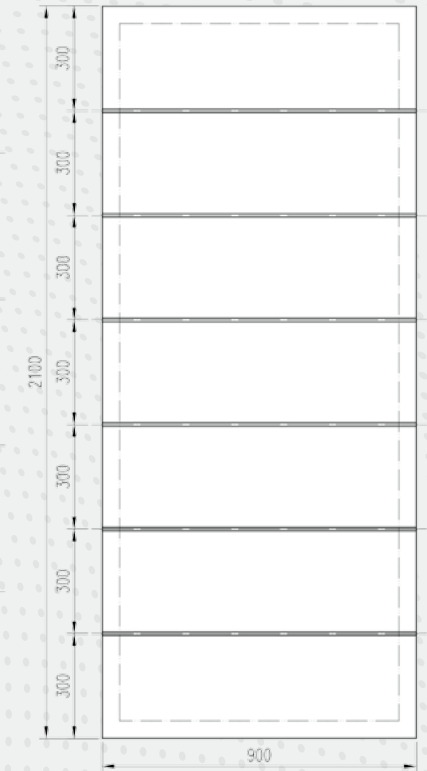

SAGITARIO



SAGITARIO
8R



- Aluminio
- Pvc
- Lacado Ral
- Anodizado
- Lacado Madera
- Foliado

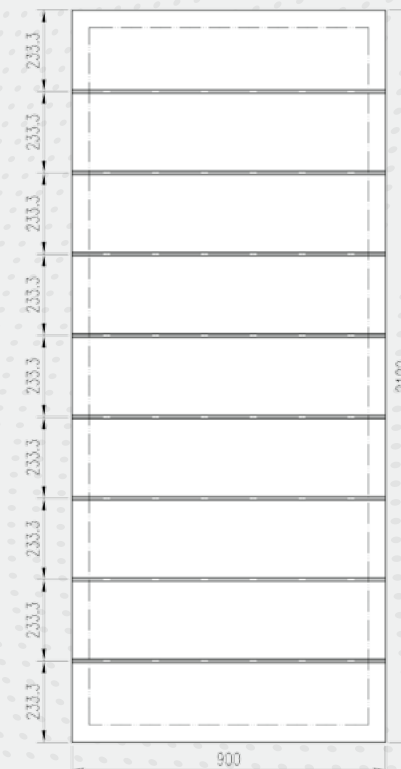

SERPEN



SERPEN
3R



- Aluminio
- Pvc
- Lacado Ral
- Anodizado
- Lacado Madera
- Foliado

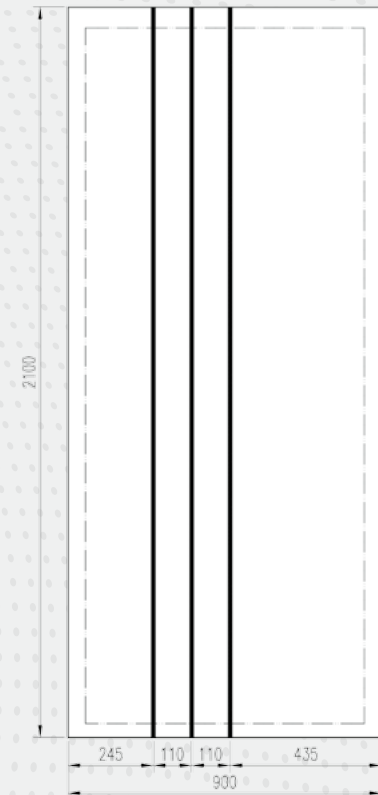

SIGMA



SIGMA



SIGMA
4 vidrios mate



- Aluminio
- Pvc
- Lacado Ral
- Anodizado
- Lacado Madera
- Foliado

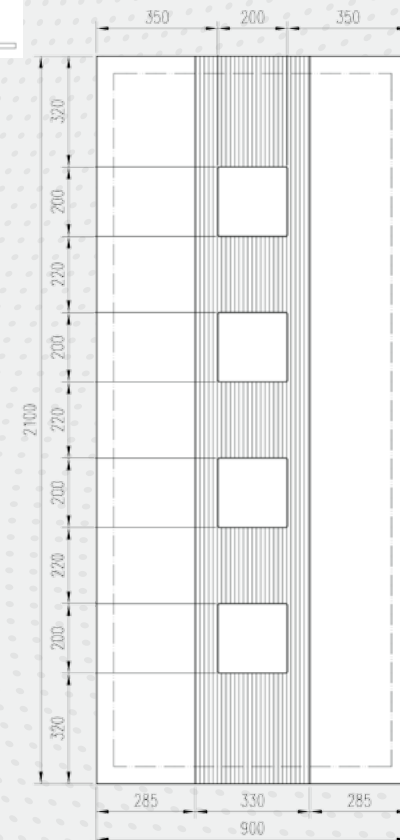

TAU



TAU
3 vidrios mate



- Aluminio
- Pvc
- Lacado Ral
- Anodizado
- Lacado Madera
- Foliado

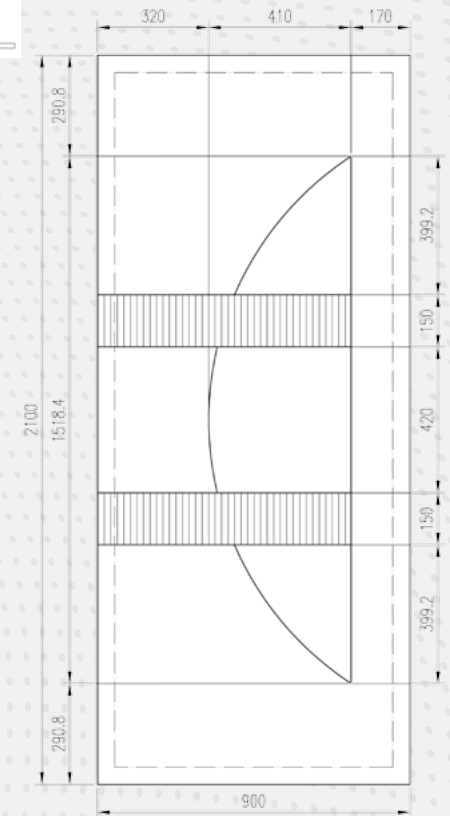

TAURO II



TAURO II
1 vidrio mate

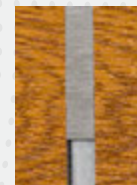

- Aluminio
- Pvc
- Lacado Ral
- Anodizado
- Lacado Madera
- Foliado

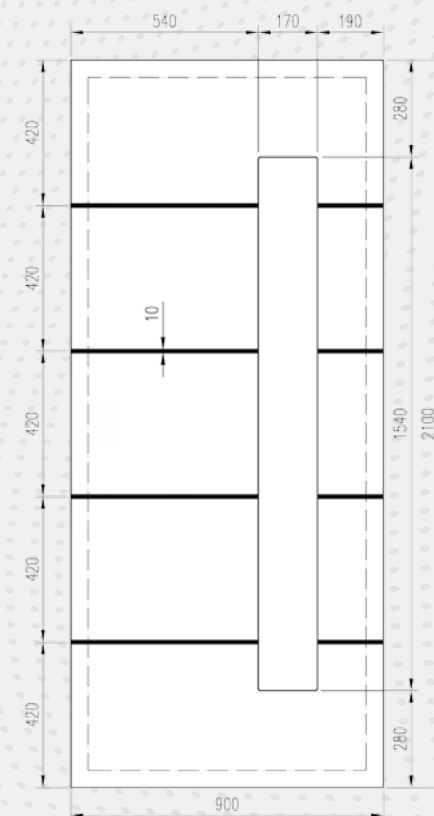

VELA



VELA
4 vidrios mate



- Aluminio
- Pvc
- Lacado Ral
- Anodizado
- Lacado Madera
- Foliado

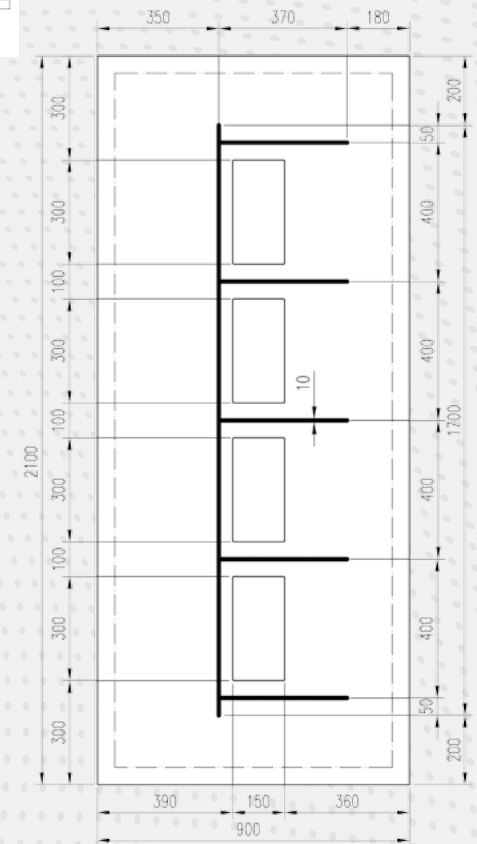

VIRGO



VIRGO

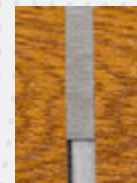

- Aluminio
- Pvc
- Lacado Ral
- Anodizado
- Lacado Madera
- Foliado

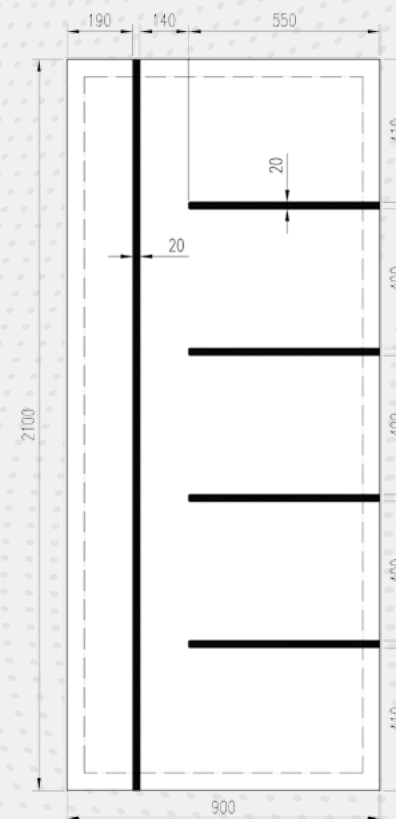





PVC CONFORMADO

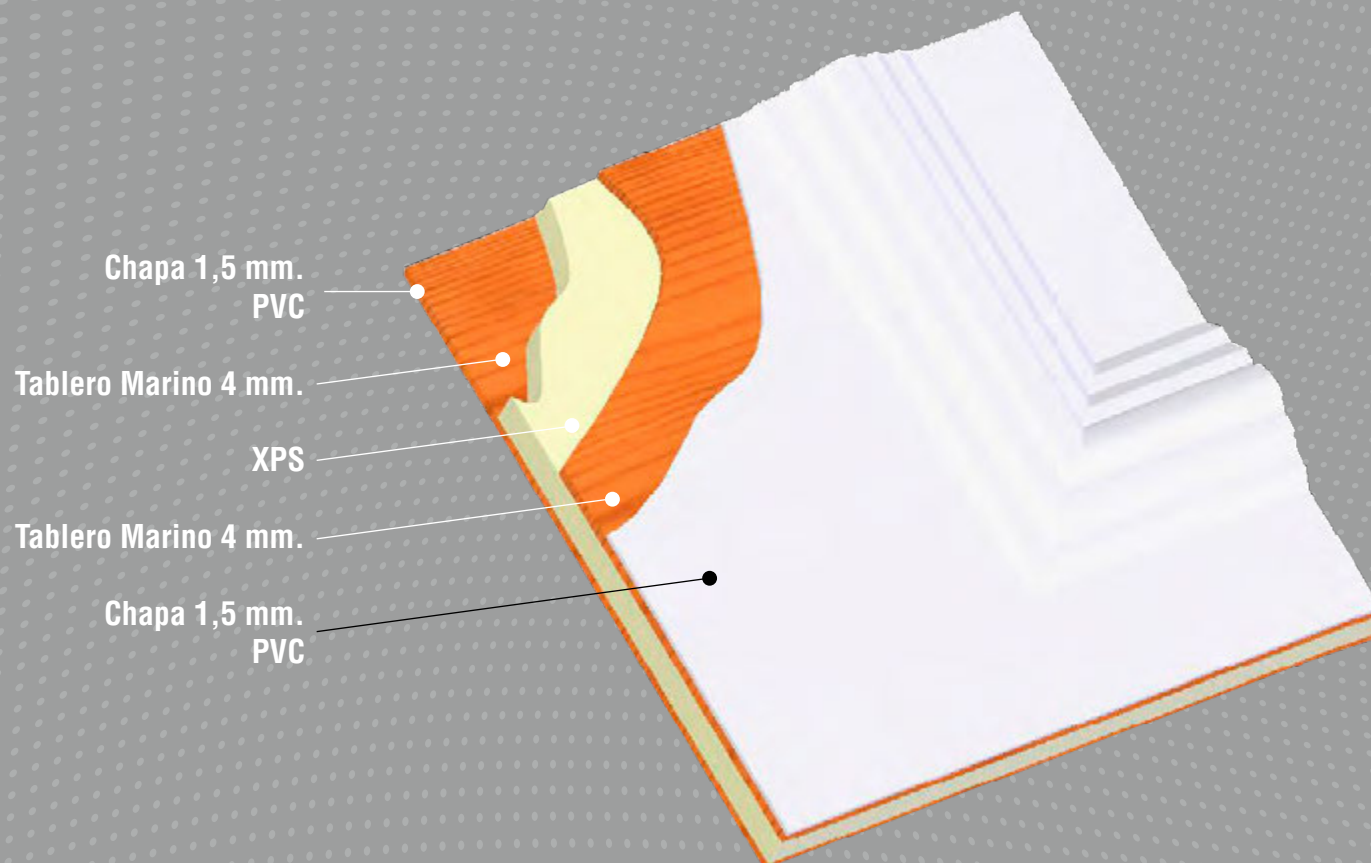

NÚCLEOS

XPS: $U = 1,57 \text{ W/m}^2 \text{ }^\circ\text{K}$

ALMA MIXTA: $U = 2,03 \text{ W/m}^2 \text{ }^\circ\text{K}$

TABLERO MARINO: $U = 2,77 \text{ W/m}^2 \text{ }^\circ\text{K}$

OPCIONES

Refuerzo Chapa Aluminio
Blindaje Chapa Acero

MEDIDAS FABRICACIÓN

2100 x 900

ACABADOS

PVC BLANCO

Vista de todos los modelos: Exterior.

DIANA



DIANA



DIANA
2 vidrios mate



DIANA
4 vidrios mate

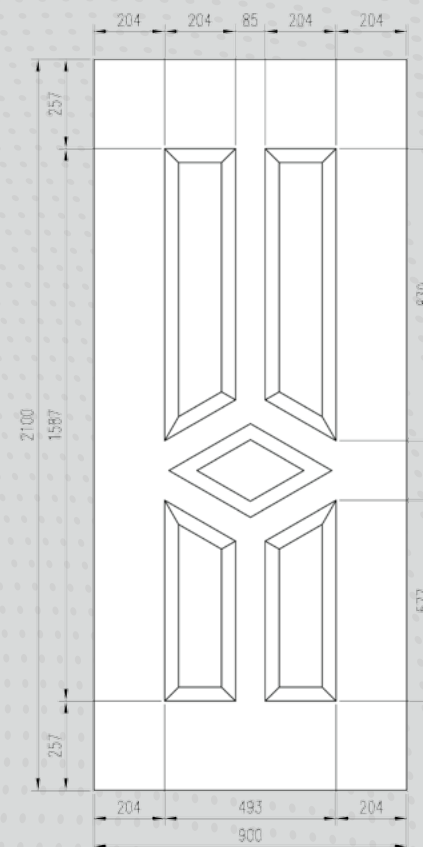

HADES



HADES



HADES



HADES
2R



HADES
2X2

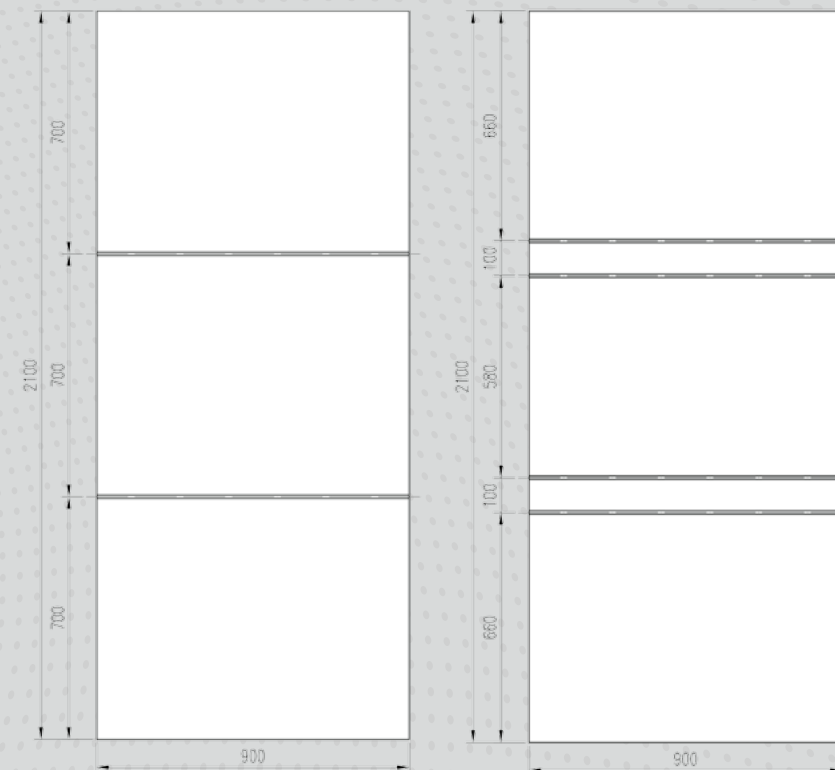

HADES



HADES
3R



HADES
3X2

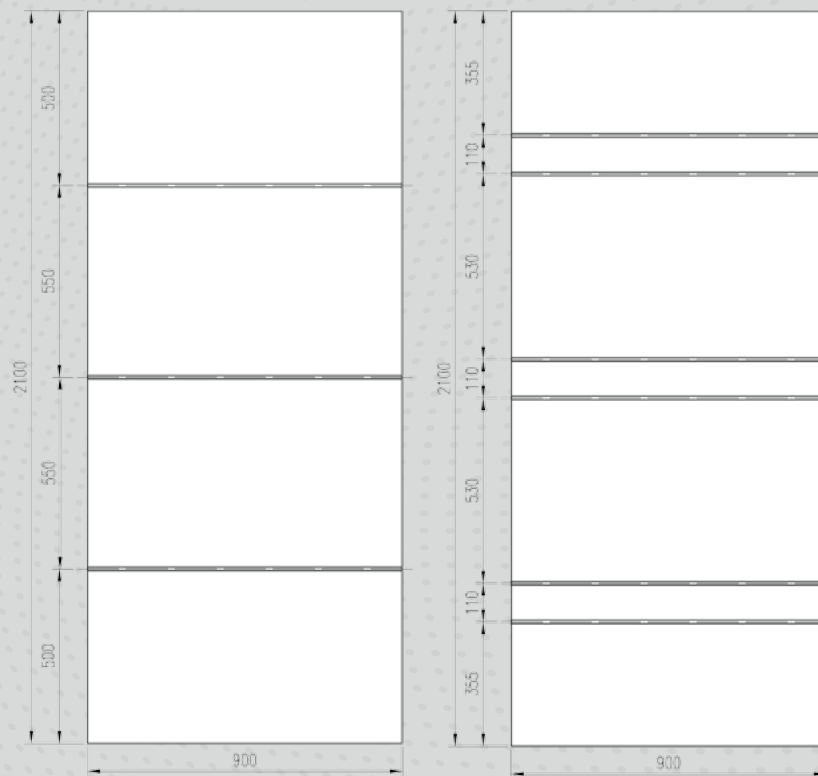

HADES



HADES
4R



HADES
6R



HADES



HADES
8R

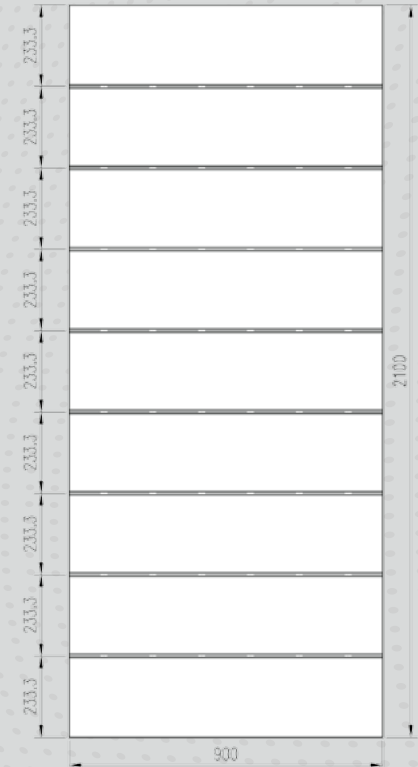

IRIS



IRIS



IRIS
2R

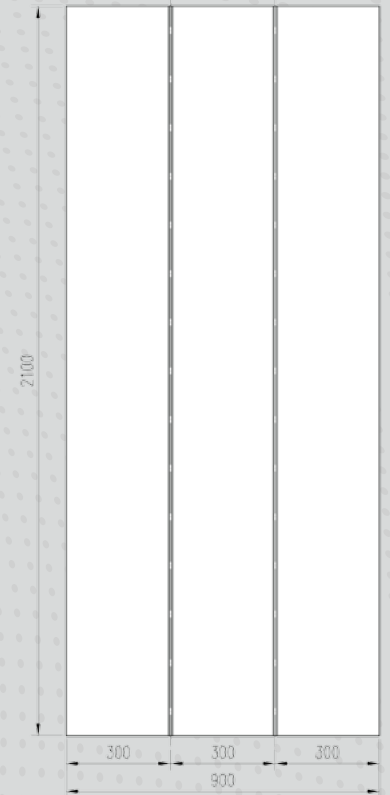
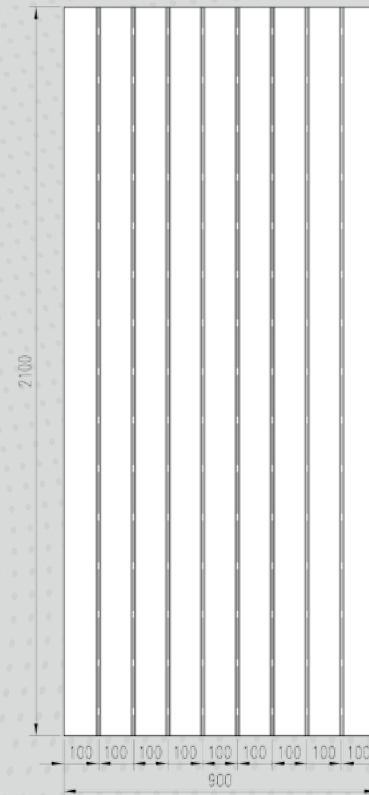

IRIS



IRIS
3R



IRIS
3R 200

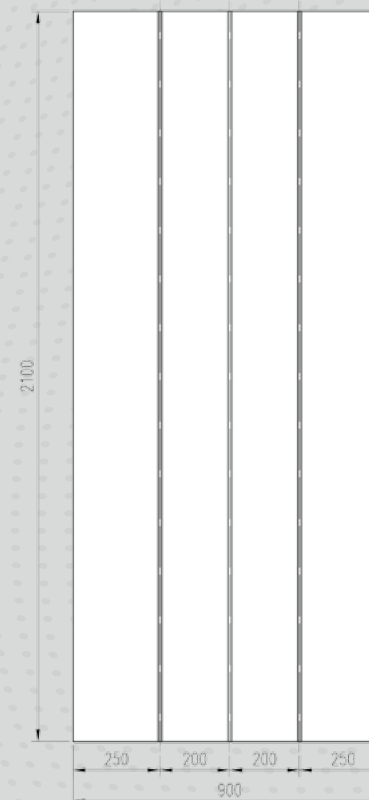
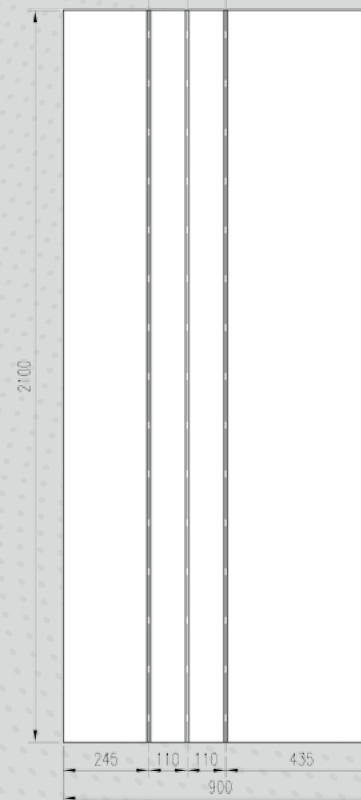

IRIS



IRIS
4R

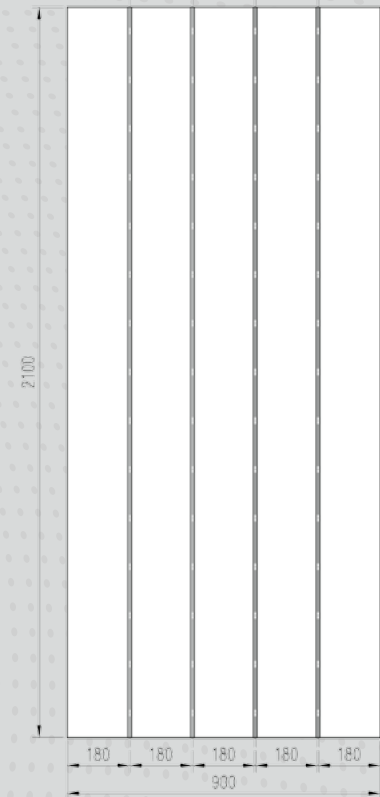

JÚPITER



JÚPITER



JÚPITER
1 vidrio mate

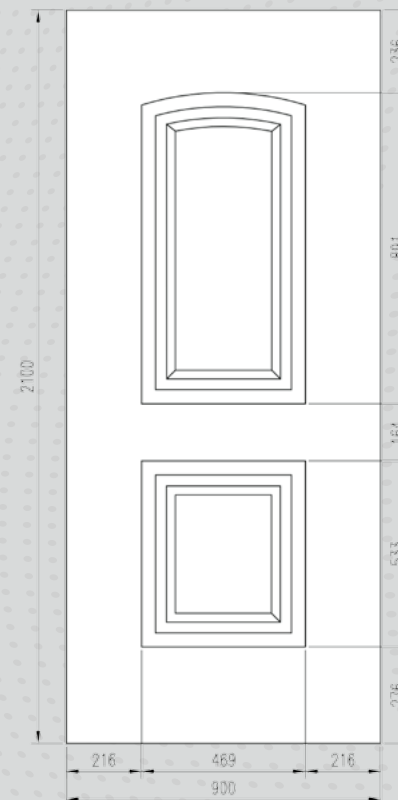

MARTE



MARTE



MARTE
2 vidrios mate



MARTE
4 vidrios mate

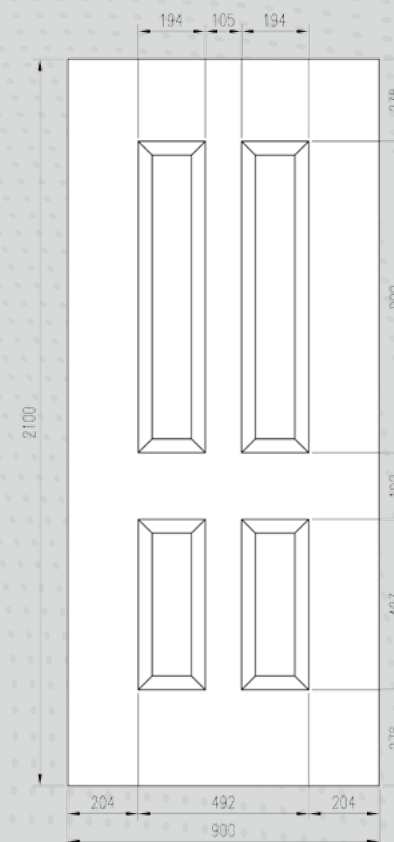

ORIÓN



ORIÓN



ORIÓN
1 vidrio mate



ORIÓN
3 vidrios mate



ORIÓN
5 vidrios mate

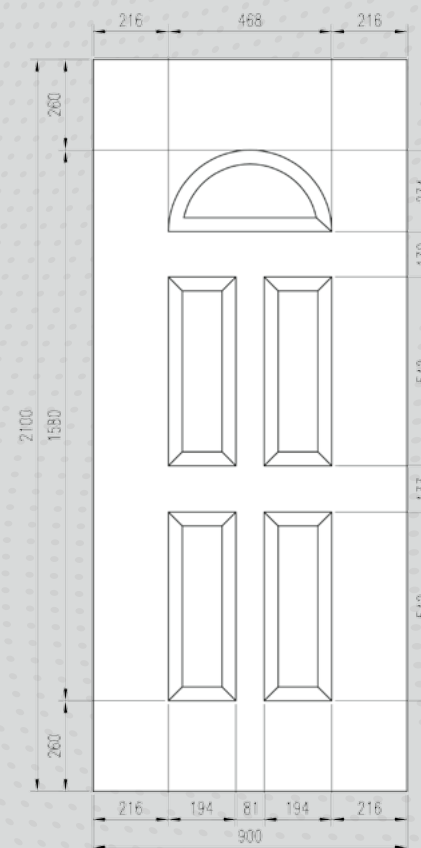

POSEIDÓN



POSEIDÓN



POSEIDÓN
1 vidrio mate

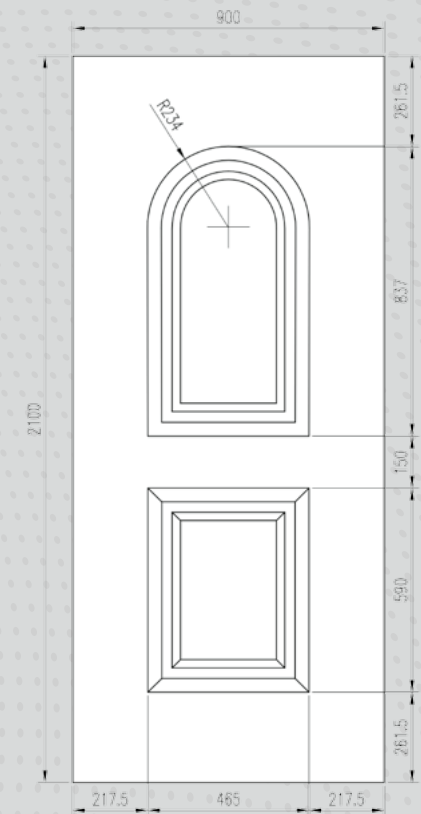

SEXTANTE



SEXTANTE



SEXTANTE
3 vidrios mate

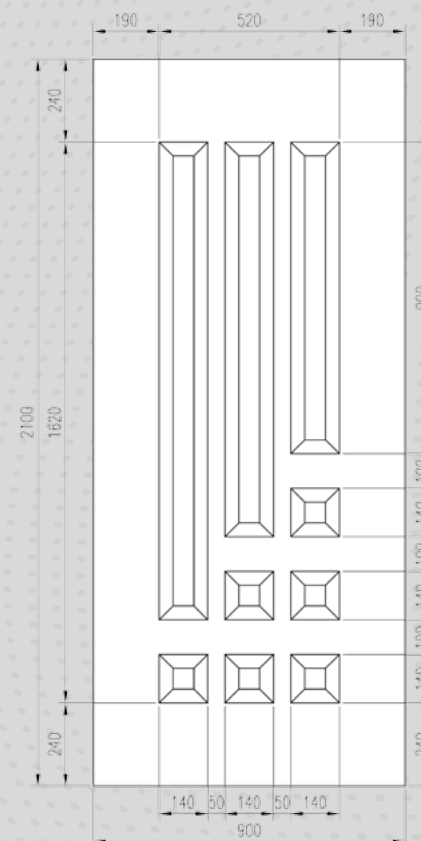





ACCESORIOS

ALUMINIO
INOX
REJAS ALUMINIO

ALUMINIO



950200-0



950200-1



950200-P



950200-N



950231-0



950231-1



950231-P



950231-N



950231-B



950205-0



950205-1



950205-P



950205-N



950205-B



950232-0



950232-1



950232-P



950232-N



950232-B



950215-0



950215-1



950215-P



950215-N



950235-0



950235-1



950235-P



950235-N



950235-B



950237-P



950236-P



950237-N



950236-N



950240-0



950240-1



950240-N



950242-N



950210-0



950210-1

ALUMINIO



950221-N 950222-N



950221-P 950222-P



950223-N 950224-N



950223-P 950224-P



950261-P 85 mm. 950262-P 85 mm.
950264-P 92 mm. 950265-P 92 mm.

950260-P Jgo 85 mm.
950263-P Jgo 92 mm.



950261-N 85 mm. 950262-N 85 mm.
950264-N 92 mm. 950265-N 92 mm.

950260-N Jgo 85 mm.
950263-N Jgo 92 mm.



950261-I 85 mm. 950262-I 85 mm.
950264-I 92 mm. 950265-I 92 mm.

950260-I Jgo 85 mm.
950263-I Jgo 92 mm.



950261-B 85 mm. 950262-B 85 mm.
950264-B 92 mm. 950265-B 92 mm.

950260-B Jgo 85 mm.
950263-B Jgo 92 mm.



950261-O 85 mm. 950262-O 85 mm.
950264-O 92 mm. 950265-O 92 mm.

950260-O Jgo 85 mm.
950263-O Jgo 92 mm.

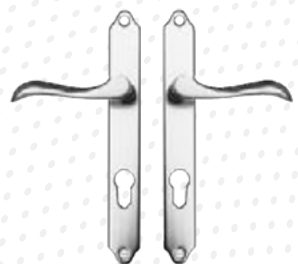

950226-P 85 mm. 950227-P 85 mm.
950229-P 92 mm. 950230-P 92 mm.

950225-P Jgo 85 mm.
950228-P Jgo 92 mm.



950226-N 85 mm. 950227-N 85 mm.
950229-N 92 mm. 950230-N 92 mm.

950225-N Jgo 85 mm.
950228-N Jgo 92 mm.

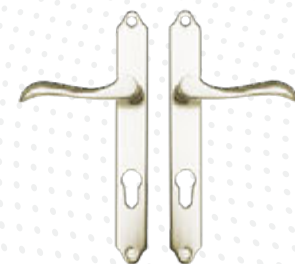

950226-I 85 mm. 950227-I 85 mm.
950229-I 92 mm. 950230-I 92 mm.

950225-I Jgo 85 mm.
950228-I Jgo 92 mm.

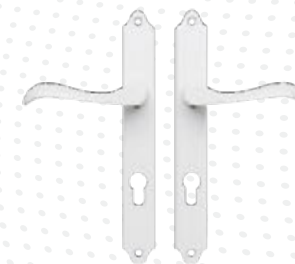

950226-B 85 mm. 950227-B 85 mm.
950229-B 92 mm. 950230-B 92 mm.

950225-B Jgo 85 mm.
950228-B Jgo 92 mm.

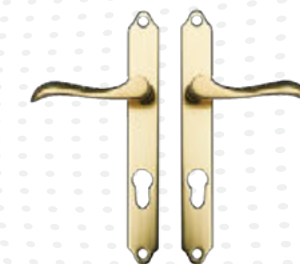

950226-O 85 mm. 950227-O 85 mm.
950229-O 92 mm. 950230-O 92 mm.

950225-O Jgo 85 mm.
950228-O Jgo 92 mm.

INOX

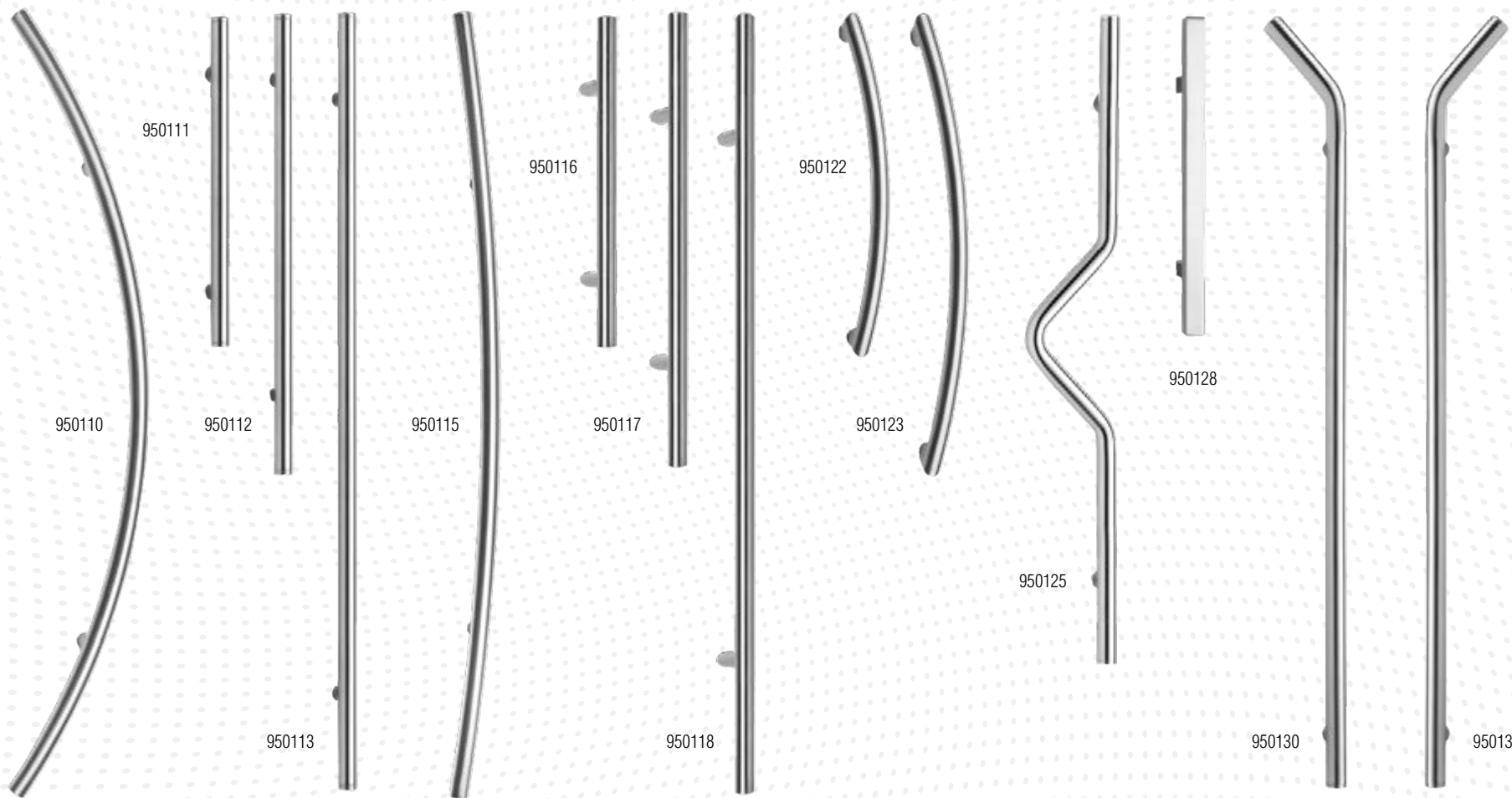

INOX



950129



950137



950138



950151



950150



950139



950140



950142 85 mm.
950145 92 mm.

950143 85 mm.
950146 92 mm.

950141 Jgo 85 mm.
950144 Jgo 92 mm.

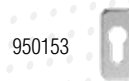

950153



950152

REJAS DE ALUMINIO



REJA 4
310 x 1.680 mm.

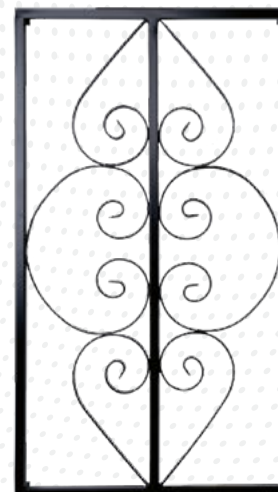

REJA 3
460 x 810 mm.



REJA 2
270 x 600 mm.



REJA 1
460 x 460 mm.

ALUMINIO

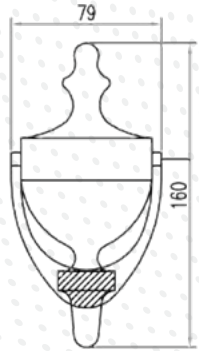

950200

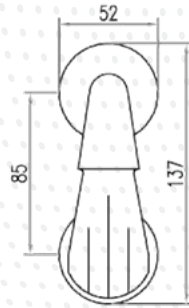

950205

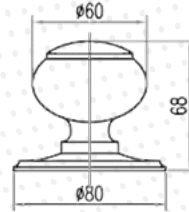

950231

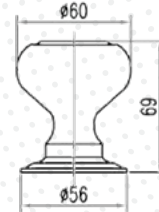

950232



950240

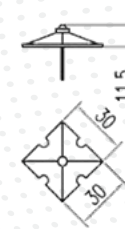

950242

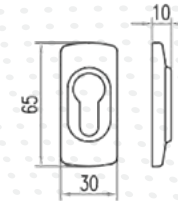

950235

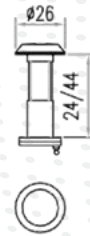

950210

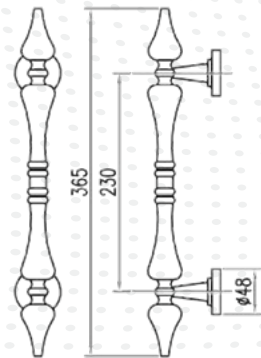

950215

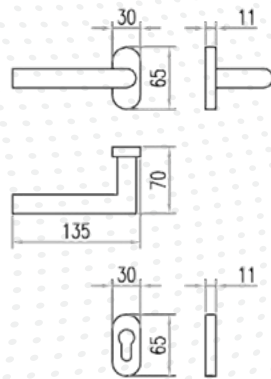

REFERENCIA	IZQ.	DER.
MANILLA	950221	950222
ESCUDO	950236	

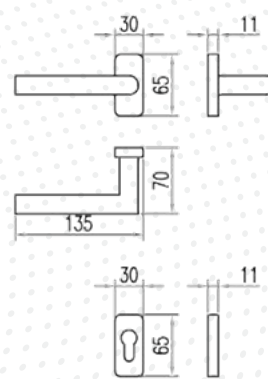

REFERENCIA	IZQ.	DER.
MANILLA	950223	950224
ESCUDO	950237	

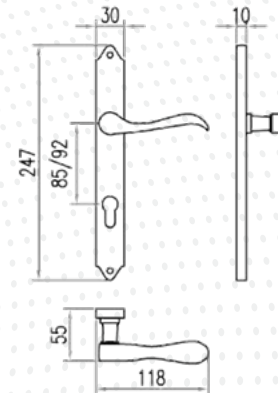

DISTANCIA	JUEGO	IZQ.	DER.
85	950225	950226	950227
92	950228	950229	950230

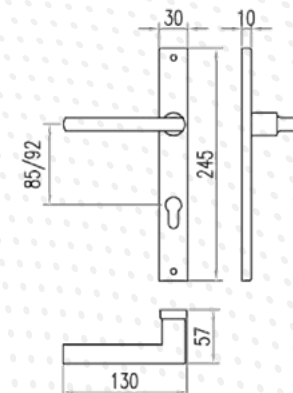

DISTANCIA	JUEGO	IZQ.	DER.
85	950260	950261	950262
92	950263	950264	950265

INOX

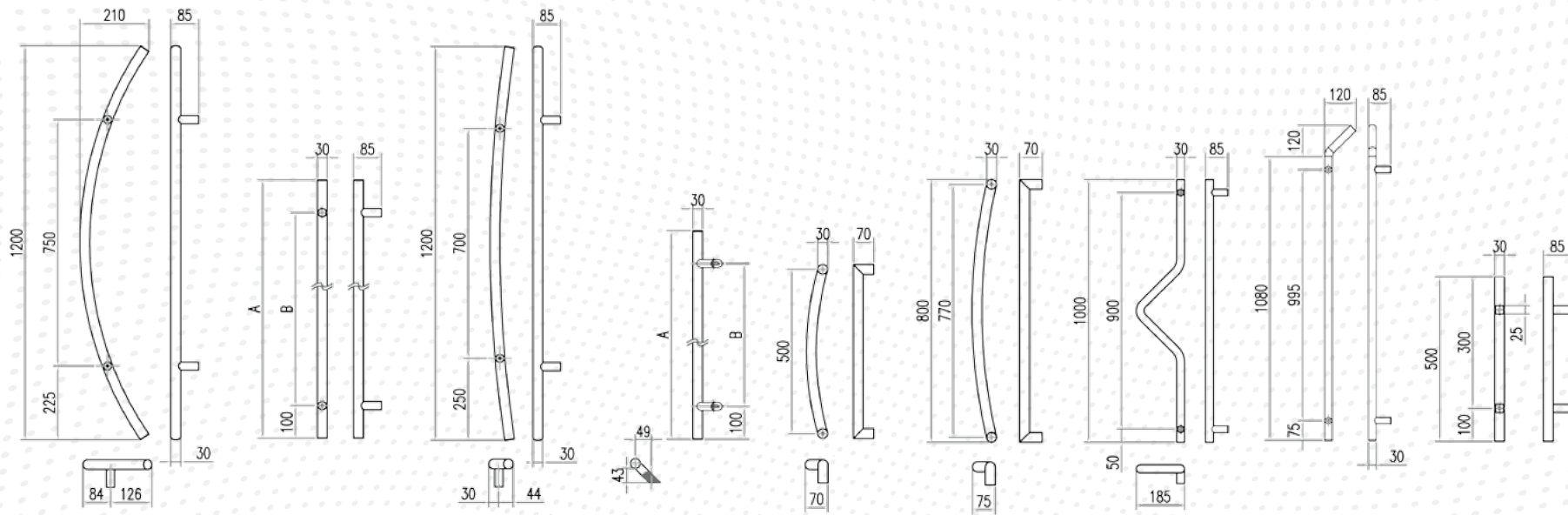

REFERENCIA	A	B
950110	500	300
950111	700	500
950112	1200	1000
950113		

REFERENCIA	A	B
950114	500	300
950115	700	500
950116	1200	1000
950117		
950118		

REFERENCIA	A	B
950119	800	770
950120	1000	900
950121	1080	995
950122		
950123		
950124		
950125		
950126		
950127		
950128		
950129		

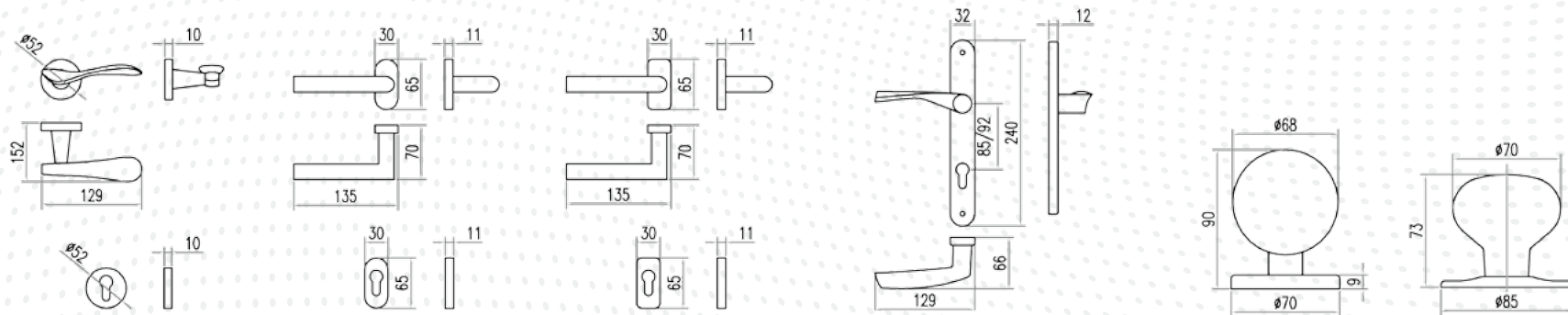

REFERENCIA	IZQ.	DER.
950129	950137	950138
MANILLA	950137	950138
ESCUDO	950152	

REFERENCIA	IZQ.	DER.
950130	950139	950140
MANILLA	950139	950140
ESCUDO	950153	

DISTANCIA	JUEGO	IZQ.	DER.
85	950141	950261	950262
92	950144	950264	950265

REFERENCIA	A	B
950150		
950151		

LISTADO DE ACCESORIOS

ALUMINIO

950200-N	Llamador copa lacado negro
950200-O	Llamador copa anodizado oro
950200-P	Llamador copa anodizado plata
950200-I	Llamador copa anodizado inox
950205-B	Llamador mano lacado blanco
950205-N	Llamador mano lacado negro
950205-O	Llamador mano anodizado oro
950205-P	Llamador mano anodizado plata
950205-I	Llamador mano anodizado inox
950210-O	Mirilla oro
950210-I	Mirilla inox
950215-N	Tirador macizo para recta lacado negro
950215-O	Tirador macizo para recta anodizado oro
950215-P	Tirador macizo para recta anodizado plata
950215-I	Tirador macizo para recta anodizado inox
950221-N	Manilla base ovalada Izda negra
950221-P	Manilla base ovalada Izda plata
950222-N	Manilla base ovalada Dcha negra
950222-P	Manilla base ovalada Dcha plata
950223-N	Manilla base rectangular Izda negra
950223-P	Manilla base rectangular Izda plata
950224-N	Manilla base rectangular Dcha negra
950224-P	Manilla base Rectangular Dcha plata
950225-B	Jgo Manilla epoca bocallave 85mm lacado blanco
950225-N	Jgo Manilla epoca bocallave 85mm lacado negro
950225-O	Jgo Manilla epoca bocallave 85mm anodizado oro
950225-P	Jgo Manilla epoca bocallave 85mm anodizado plata

950225-I	Jgo Manilla epoca bocallave 85mm lacado inox
950226-B	Manilla epoca bocallave izda 85mm lacado blanco
950226-N	Manilla epoca bocallave izda 85mm lacado negro
950226-O	Manilla epoca bocallave izda 85mm anodizado oro
950226-P	Manilla epoca bocallave izda 85mm anodizado plata
950226-I	Manilla epoca bocallave izda 85mm lacado inox
950227-B	Manilla epoca bocallave dcha 85mm lacado blanco
950227-N	Manilla epoca bocallave dcha 85mm lacado negro
950227-O	Manilla epoca bocallave dcha 85mm anodizado oro
950227-P	Manilla epoca bocallave dcha 85mm anodizado plata
950227-I	Manilla epoca bocallave dcha 85mm lacado inox
950228-B	Jgo Manilla epoca bocallave 92mm lacado blanco
950228-N	Jgo Manilla epoca bocallave 92mm lacado negro
950228-O	Jgo Manilla epoca bocallave 92mm anodizado oro
950228-P	Jgo Manilla epoca bocallave 92mm anodizado plata
950228-I	Jgo Manilla epoca bocallave 92mm lacado inox
950229-B	Manilla epoca bocallave izda 92mm lacado blanco
950229-N	Manilla epoca bocallave izda 92mm lacado negro
950229-O	Manilla epoca bocallave izda 92mm anodizado oro
950229-P	Manilla epoca bocallave izda 92mm anodizado plata
950229-I	Manilla epoca bocallave izda 92mm lacado inox
950230-B	Manilla epoca bocallave dcha 92mm lacado blanco
950230-N	Manilla epoca bocallave dcha 92mm lacado negro
950230-O	Manilla epoca bocallave dcha 92mm anodizado oro
950230-P	Manilla epoca bocallave dcha 92mm anodizado plata
950230-I	Manilla epoca bocallave dcha 92mm lacado inox
950231-B	Pomo macizo base ancha lacado blanco

950231-N	Pomo macizo base ancha lacado negro
950231-O	Pomo macizo base ancha anodizado oro
950231-P	Pomo macizo base ancha anodizado plata
950231-I	Pomo macizo base ancha anodizado inox
950232-B	Pomo macizo base estrecha lacado blanco
950232-N	Pomo macizo base estrecha lacado negro
950232-O	Pomo macizo base estrecha anodizado oro
950232-P	Pomo macizo base estrecha anodizado plata
950232-I	Pomo macizo base estrecha anodizado inox
950235-B	Escudo bombillo lacado blanco
950235-N	Escudo bombillo lacado negro
950235-O	Escudo bombillo lacado oro
950235-P	Escudo bombillo lacado plata
950235-I	Escudo bombillo lacado inox
950236-N	Escudo bombillo ovalado negro
950236-P	Escudo bombillo ovalado plata
950237-N	Escudo bombillo rectangular negro
950237-P	Escudo bombillo rectangular plata
950240-N	Clavo decorativo redondo lacado negro
950240-O	Clavo decorativo redondo lacado oro
950240-I	Clavo decorativo redondo lacado inox
950242-N	Clavo decorativo cuadrado lacado negro
950260-B	Jgo manilla moderna placa recta 85mm lacado blanco
950260-N	Jgo manilla moderna placa recta 85mm lacado negro
950260-O	Jgo manilla moderna placa recta 85mm anodizado oro
950260-P	Jgo manilla moderna placa recta 85mm anodizado plata
950260-I	Jgo manilla moderna placa recta 85mm anodizado inox

VIDRIOS ESTÁNDAR



MATE

VIDRIOS ESPECIALES 1

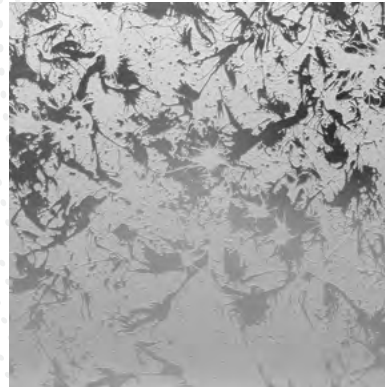

ESCARCHA

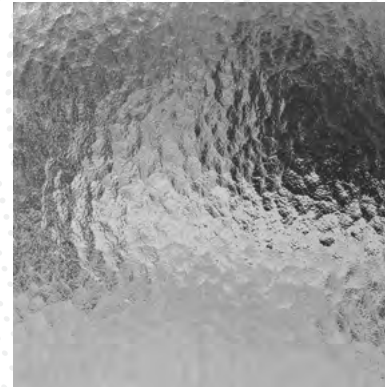

CATEDRAL

VIDRIOS ESPECIALES 2

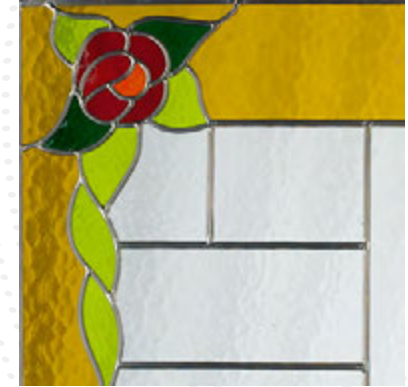

EMPLOMADO

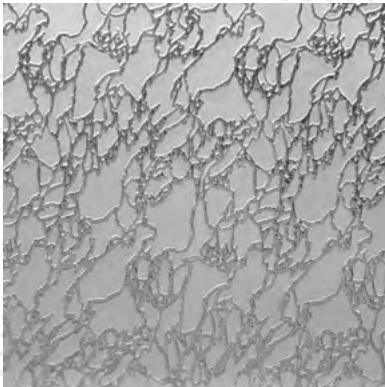

DELTA

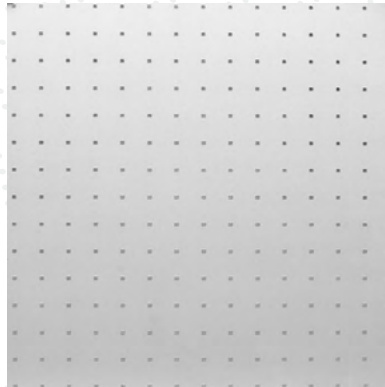

PIKS



ESPIGA

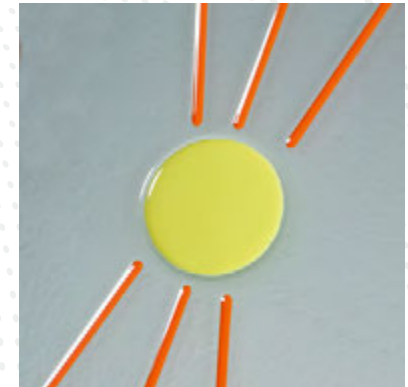

FUSSING

Todos los acristalamientos están formados por vidrio laminar en su cara exterior.

OTROS PRODUCTOS

PANEL SANDWICH ALUMINIO O PVC

Panel Sándwich Liso o Ranurado, compuesto por dos chapas de aluminio o PVC y núcleo de Poliestireno Extruido de calidad industrial XPS.

ACABADOS	DIMENSIONES ESTÁNDAR	ESPEORES
Lacados RAL	2000 x 1000 mm.	Cualquier espesor comprendido entre 6 y 120 mm.
Anodizados	3000 x 1250 mm.	
Lacados símil madera	3000 x 1500 mm.	
Foliado		

CHAPA FOLIADA

Chapa foliada (Renolit/Hornschuch) en stock en más de 50 acabados, en las siguientes medidas:

2100 x 900 mm.

3000 x 1250 mm.

POLIESTIRENO EXTRUIDO

Laminamos bloques de Poliestireno Extruido XPS industrial en cualquier espesor, desde 3 mm hasta 120 mm en las siguientes medidas:

2000 x 800 mm.

2100 x 900 mm.

2000 x 1000 mm.

3000 x 1250 mm.



PUERTA AVANZA

Consulte en nuestro catálogo de puerta acabada.

www.estega.es





LICENCIA Nº. ES-0020F



LICENCIA Nº. 475



LICENCIA Nº. 12.248





ESTAMPACIONES TÉCNICAS DE GALICIA, S.L.

A Reigosa, 1

36828 Ponte Caldelas - Pontevedra

Tlf.: 34 986 757 979

Fax: 34 986 757 978

info@estega.es

www.estega.es

